

Warehouse & Industry



Contact Sono on +46 (0) 10 161 54 00 or info@sono.se

SONO



Content

Heavy duty work tables	6
Lightweight work tables	14
Raise and lower work table	18
ESD Work Space	34
Packing table	42
Desk Accessories	46
Drawer sections	56
Floor racks and trolleys	60
Accessories for floor racks and trolleys	62
Workshop	70
Tool cleaning	78
Industrial chairs	86
Industrial Mats	116

Our Brands



GBP

GBP Ergonomics is our own brand for furnishing ergonomic workplaces for industry, workshops and warehouses. GBP was established in 1905 and is today one of Scandinavia's leading manufacturers of work tables, cabinets, drawers and industrial chairs for people who want an ergonomic and functional working day.



ergoff

Ergoff is a brand beyond the ordinary in office furnishings. The purpose of Ergoff products is to harness the potential of each individual by creating the right conditions for optimum performance in the office environment. Innovation and sustainability are keywords that Ergoff's brand stands for. For many years, Ergoff products have been marketed to promote movement, variety and recovery. Ever since 1995, when digitalization took off, there has been a focus on well-being in the office workplace - and the goal is to have a positive impact in the communities where we live and work.



We have been furnishing schools and kindergartens for over 25 years. Providing children with an inspiring and creative environment has always been important to us. That's why we offer a wide range of flexible total concepts and interior design solutions. In this way, we meet the school's need for playful and stimulating living spaces, and environments that create cohesion and well-being for the benefit of students and teachers.



Our story started in school in 1896 – and today, in a completely new era, we are still strongly present. Our knowledge is found in the walls of the school, and is reflected in our furniture. Our production takes place locally and reduces the distance between raw materials and finished product. It gives us proximity to the end users and the school environments where the furniture is used. Over a hundred years in school have made us safe on the "school bench". But we are always responsive and innovative to find even better products and solutions that satisfy modern schools' need for a good learning environment.



SARPSBORG METALL

Sarpsborg Metall is our own brand for wardrobe, storage and filing cabinets for schools, workshops, warehouses and offices. The products have been on the market for over 80 years – and can be found in most school environments in Norway. In addition to a wide range of standard products, we also offer tailor-made design solutions for your specific needs.

Ergonomic workplaces for industry, workshop and warehouse

GBP Ergonomics is our own brand for furnishing ergonomic workplaces for industry, workshops and warehouses. GBP was established in 1905 and is today one of Scandinavia's leading manufacturers of work tables, cabinets, drawers and industrial chairs for people who want an ergonomic and functional working day.

GBP



GBP is changing the color of the product range!

In February, we changed the color of the entire industrial range under the brand GBP. Our new color scheme has a light gray base and a dark gray accent color. The reason for the color change is that the working environment in the workshop and industrial sector has evolved over the years. Now, there is a desire for a clean and stylish work environment where the interior is both functional and elegant. With this change in color, we present the market with a timeless design. Products such as tool boards and tool cabinets will still be available in our classic blue color. You will still be able to purchase products in the old colors for a limited period, and as long as stock lasts.



Heavy duty work tables

Highly stable legrests, designed for use with our 40mm tabletops. The leg trestles are delivered individually, for plate depth 600 / 620 mm respectively. 800 mm, and has a capacity of 750 kg distributed load (500 kg. with wheels). The working height is 700 - 970 mm without table top. For table tops with a width of 2500 mm, we recommend the use of 3 leg stands.

- Stable & Flexible
- Capacity 750/500 kg
- Wide range of items



Specifications

- Maximum load: 750/500 kg evenly distributed
- Manual height adjustment without table top: 700–970 mm
- Manual height adjustment without table top, including castors: 850–1120 mm

GBP

Complete the table!

Build your complete work table with drawer sections, bodywork and accessories. View from page 48.

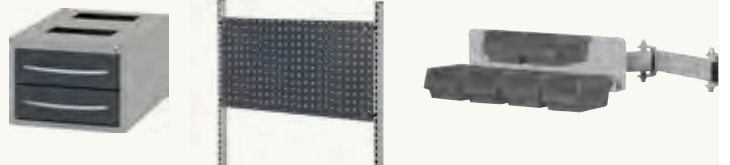

VINYL



Workshop bench w/vinyl tabletop

Complete workshop table including adjustable leg racks and 40mm tabletop with grey vinyl finish. Vinyl is a popular all-round tabletop for e.g. packing and assembly work, but with limited resistance to solvents. The worktops are pre-drilled with screw inserts for leg brackets and drawer sections, and consist of chipboard and laminated fibreboard. Capacity is 750 kg distributed load and working height is 740 - 1010 mm incl. table top. Remember to order a superstructure frame, if you want a superstructure on these workshop benches.

Border colour	Mocha grey	
Undercarriage Color	Grey RAL7004	
	SKU	Price
1200 x 800	636773	*
1500 x 800	636757	*
2500 x 800	636826	*
2000 x 800	636896	*

HPL



Workshop bench w/HPL worktop

Complete workshop table including leg stands and 40 mm tabletop with grey HPL surface. The HPL surface provides a table top with high scratch resistance and is resistant to liquids and chemicals. The worktops are pre-drilled with screw inserts for leg brackets and drawer sections, and consist of chipboard and laminated fibreboard. Capacity is 750 kg distributed load and working height is 740 - 1010 mm incl. table top. Remember to order a superstructure frame, if you want a superstructure on these workshop benches.

Border colour	Mocha grey	
Undercarriage Color	Grey RAL7004	
	SKU	Price
1200 x 620	636891	*
1500 x 620	636770	*
2000 x 620	636892	*
2500 x 620	636893	*
1200 x 800	636712	*
1500 x 800	636849	*
2000 x 800	636772	*
2500 x 800	636895	*

HPL



Workshop bench w/HPL worktop and drawers

Complete workshop table including drawer section with one, two or three drawers, leg stands and 40 mm tabletop with grey HPL surface. The HPL surface provides a table top with high scratch resistance and is resistant to liquids and chemicals. The worktops are pre-drilled with screw inserts for leg brackets and drawer sections, and consist of chipboard and laminated fibreboard. Capacity is 750 kg distributed load and working height is 740 - 1010 mm incl. table top. Remember to order a superstructure frame, if you also want a superstructure on these workshop benches.

Border colour	Mocha grey		
Undercarriage Color	Grey RAL7004		
	Size (mm)	SKU	Price
1 drawer	1200 x 800	636761	*
	1500 x 800	636917	*
	2000 x 800	636925	*
	2500 x 800	636775	*
2 drawers	1200 x 800	636899	*
	1500 x 800	636959	*
	2000 x 800	636900	*
3 drawers	2500 x 800	636924	*
	1200 x 800	636760	*
	1500 x 800	636850	*
3 drawers	2000 x 800	636958	*
	2500 x 800	636851	*

VINYL / HPL



Workshop bench w/castor and table top

Complete workshop table with trestles on wheels and 40 mm tabletop with grey vinyl or HPL finish. The worktops are pre-drilled with screw inserts for leg brackets and drawer sections, and consist of chipboard and laminated fibreboard. The wheels are fixed and by moving the hoop the legs are pushed down. The height difference between the position of the legs and the wheels is 10 mm. All wheels are with brake, Ø150 mm. The capacity is 500 kg distributed load when the table is on its feet and 300 kg when the wheels are turned out. Working height is 705 - 980 mm incl. table top.

Border colour	Mocha grey		
Undercarriage Color	Grey RAL7004		
	Size (mm)	SKU	Price
High pressure laminate	1200 x 800	637037	*
	1500 x 800	637038	*
	2000 x 800	637036	*
Vinyl	1200 x 800	637048	*
	1500 x 800	637018	*
	2000 x 800	637049	*



OAK

Workshop bench w/oak tabletop

Complete workshop table including adjustable trestles and 40 mm table top with oak parquet surface. Oak parquet is a pretty and popular table top for most work tasks. The table top has a front edge in anodised aluminium and dark grey ABS moulding on the other sides. The worktops are pre-drilled with screw inserts for leg brackets and drawer sections, and consist of chipboard and laminated fibreboard. Capacity is 750 kg distributed load and working height is 740 - 1010 mm incl. table top. Remember to order a superstructure frame, if you want a superstructure on these workshop benches.

Working height excl. table top (mm)	700 - 970	
Load (kg)	750	
Table top thickness (mm)	40	
Border colour	Aluminium/Dark grey	
Undercarriage Color	Grey RAL7004	
	SKU	Price
1200 x 800	636771	*
1500 x 800	636914	*
2000 x 800	636894	*
2500 x 800	636848	*



HPL

Workshop bench w/drawer and under shelf

Complete workshop table with under shelf, including drawer section with 1 lockable drawer (capacity 40 kg), adjustable leg racks and 40 mm table top with grey HPL surface. The HPL surface provides a table top with high scratch resistance and is resistant to liquids and chemicals. The worktops are pre-drilled with screw inserts for leg brackets and drawer sections, and consist of chipboard and laminated fibreboard. Capacity is 750 kg distributed load (40 kg for lower shelf) and working height is 740 - 1010 mm incl. table top. Remember to order a superstructure frame, if you want a superstructure on these workshop benches.

Working height excl. table top (mm)	700 - 970	
Load (kg)	750	
Table top thickness (mm)	40	
Border colour	Mocha grey	
Undercarriage Color	Grey RAL7004	
	SKU	Price
1200 x 800	636713	*
1500 x 800	636774	*
2000 x 800	636897	*



HPL

Workshop Bench - Combination 3

Workshop table including removable drawer section with 5 drawers and on wheels, leg stands and 40 mm tabletop with grey HPL surface. The HPL surface provides a table top with high scratch resistance and is resistant to liquids and chemicals. The worktops are pre-drilled with screw inserts for leg brackets and drawer sections, and consist of chipboard and laminated fibreboard. Capacity is 750 kg distributed load and working height is 740 - 1010 mm incl. table top. Remember to order a superstructure frame, if you want a superstructure on these workshop benches.

Working height excl. table top (mm)	700 - 970	
Load (kg)	750	
Table top thickness (mm)	40	
Border colour	Mocha grey	
Undercarriage Color	Grey RAL7004	
	SKU	Price
1200 x 800	636916	*
1500 x 800	636758	*
2000 x 800	636827	*
2500 x 800	636759	*



HPL

Workshop Bench - Combination 4

Complete workshop table with drawer section on wheels, a lockable drawer (capacity 40 kg), leg stands and 40 mm tabletop with grey HPL surface. The HPL surface provides a table top with high scratch resistance and is resistant to liquids and chemicals. The worktops are pre-drilled with screw inserts for leg brackets and drawer sections, and consist of chipboard and laminated fibreboard. Capacity is 750 kg distributed load and working height is 740 - 1010 mm incl. table top. Remember to order a superstructure frame, if you want a superstructure on these workshop benches.

Working height excl. table top (mm)	700 - 970	
Load (kg)	750	
Table top thickness (mm)	40	
Border colour	Mocha grey	
Undercarriage Color	Grey RAL7004	
	SKU	Price
1200 x 800	636915	*
1500 x 800	636957	*
2000 x 800	636714	*
2500 x 800	636898	*

HPL



Workshop Bench - Combination 6

Complete workshop table including lockable drawer section with 4 drawers, 1 adjustable trestle and 40 mm table top with HPL surface. The HPL surface provides a table top with high scratch resistance and is resistant to liquids and chemicals. The worktops are pre-drilled with screw inserts for the legs and drawer section, and consist of chipboard and laminated fibreboard. Capacity is 500 kg distributed load and working height is 840-1010 mm incl. table top.

Working height excl. table top (mm)	800 - 970	
Load (kg)	500	
Table top thickness (mm)	40	
Border colour	Mocha grey	
Undercarriage Color	Grey RAL7004	
	SKU	Price
1200 x 800	636903	*
1500 x 800	636763	*
2000 x 800	636799	*

HPL



Workshop Bench - Combination 8

Complete workshop table including lockable base cabinet, 1 adjustable trestle and 40 mm table top with HPL surface. The HPL surface provides a table top with high scratch resistance and is resistant to liquids and chemicals. The worktops are pre-drilled with screw inserts for leg bows and base cabinets, and consist of chipboard and laminated fibreboard. Capacity is 500 kg distributed load. The working height of the table is adjustable 840-1010 mm incl. table top.

Working height excl. table top (mm)	800 - 970	
Load (kg)	500	
Table top thickness (mm)	40	
Border colour	Mocha grey	
Undercarriage Color	Grey RAL7004	
	SKU	Price
1200 x 800	636685	*
1500 x 800	636762	*
2000 x 800	636830	*

VINYL



Workshop Bench - Combination 9

Complete workshop table including 1 lockable drawer section with 6 drawers, 3 drawer sections with 5 drawers of which 2 are equal and 40mm table top with grey vinyl surface. Vinyl is a popular all-round tabletop for e.g. packing and assembly work, but with limited resistance to solvents. The worktops are pre-drilled with screw inserts for leg brackets and drawer sections, and consist of chipboard and laminated fibreboard. Capacity is 500 kg distributed load and working height is 840 - 1010 mm incl. table top.

Chassis size (mm)	2370 x 745	
Load (kg)	500	
Table top thickness (mm)	40	
Border colour	Dark Grey	
Undercarriage Color	Grey RAL7004	
	SKU	Price
2500 x 800	636936	*

VINYL



Workshop Bench - Combination 10

Complete workshop table including 1 lockable drawer section with 5 drawers, 1 cabinet section and 40mm table top with grey vinyl surface. Vinyl is a popular all-round tabletop for e.g. packing and assembly work, but with limited resistance to solvents. The worktops are pre-drilled with screw inserts for the legs and drawer section, and consist of chipboard and laminated fibreboard. Capacity is 500 kg distributed load and working height is 840 - 1010 mm incl. table top.

Chassis size (mm)	2370 x 745	
Load (kg)	500	
Table top thickness (mm)	40	
Border colour	Mocha grey	
Undercarriage Color	Grey RAL7004	
	SKU	Price
2500 x 800	636795	*



HPL

Workshop Bench - Combination 1

Complete workshop table including complete superstructure, adjustable leg racks and 40 mm tabletop with grey HPL surface. The superstructure contains 1 suspension strip, 1 tool board and 2 adjustable shelves. The HPL surface provides a table top with high scratch resistance and is resistant to liquids and chemicals. The worktops are pre-drilled with screw inserts for leg brackets and drawer sections, and consist of chipboard and laminated fibreboard. Capacity is 750 kg distributed load and working height is 740 -1010 mm.

Working height excl. table top (mm)	700 - 970	
Load (kg)	750	
Table top thickness (mm)	40	
Border colour	Mocha grey	
Undercarriage Color	Grey RAL7004	
	SKU	Price
1500 x 800	636946	*
2000 x 800	636699	*
2500 x 800	636703	*



HPL

Workshop Bench - Combination 5

Complete workshop table including superstructure, height-adjustable leg racks and 40 mm tabletop with grey HPL surface. The extension contains two tool boards, tool cabinets and three suspension strips for modular boxes. The HPL surface provides a table top with high scratch resistance and is resistant to liquids and chemicals. The worktops are pre-drilled with screw inserts for leg brackets and drawer sections, and consist of chipboard and laminated fibreboard. Capacity is 750 kg distributed load. Module boxes are ordered separately depending on the desired size and quantity.

Working height excl. table top (mm)	700 - 970	
Load (kg)	750	
Table top thickness (mm)	40	
Border colour	Mocha grey	
Undercarriage Color	Grey RAL7004	
	SKU	Price
2000 x 800	636698	*
2500 x 800	636886	*



HPL

Workshop Bench - Combination 2

Complete workshop table including full extension, movable drawer section with five drawers on wheels, leg brackets and 40 mm tabletop with grey HPL surface. The extension contains two tool boards, two adjustable shelves and a hanging strip for modular boxes. The HPL surface provides a table top with high scratch resistance and is resistant to liquids and chemicals. The worktops are pre-drilled with screw inserts for leg brackets and drawer sections, and consist of chipboard and laminated fibreboard. Capacity is 750 kg distributed load. Module boxes are ordered separately depending on the desired size and quantity.

Working height excl. table top (mm)	700 - 970	
Load (kg)	750	
Table top thickness (mm)	40	
Border colour	Mocha grey	
Undercarriage Color	Grey RAL7004	
	SKU	Price
1500 x 800	636945	*
2000 x 800	636810	*
2500 x 800	636838	*



HPL

Workshop Bench - Combination 7

Complete workshop table including bodywork, adjustable leg racks and 40 mm tabletop with grey HPL surface. The superstructure contains 1 tool board and an adjustable shelf (CC 900 mm). The HPL surface provides a table top with high scratch resistance and is resistant to liquids and chemicals. The worktops are pre-drilled with screw inserts for leg brackets and drawer sections, and consist of chipboard and laminated fibreboard. Capacity is 750 kg distributed load and working height is 740 - 1010 mm.

Working height excl. table top (mm)	700 - 970	
Load (kg)	750	
Table top thickness (mm)	40	
Border colour	Mocha grey	
Undercarriage Color	Grey RAL7004	
	SKU	Price
1200 x 800	636943	*
1500 x 800	636835	*
2000 x 800	636811	*
2500 x 800	636839	*



GBP



Workshop Bench – Combination 12

Complete workshop table including four tool boards 480 x 640 mm, lockable drawer (Cap. 25kg), leg trestles and 40 mm table top with oak parquet surface. Oak parquet is an attractive and popular worktop for most tasks - the front edge is anodised aluminium, the other sides with dark grey ABS moulding for good protection. The worktops are pre-drilled with screw inserts for leg brackets and drawer sections, and consist of chipboard and laminated fibreboard. Capacity is 750 kg distributed load and the workshop table has a working height of 740 - 1010 mm incl. table top.

Working height excl. table top (mm)	700 - 970
Load (kg)	750
Table top thickness (mm)	40
Border colour	Aluminium/Dark grey
Undercarriage Color	Grey RAL7004

	SKU	Price
1500 x 800	636803	*

Build your own desk

Highly stable legrests, designed for use with our 40mm tabletops. The leg trestles are delivered individually, for plate depth 600 / 620 mm respectively. 800 mm, and has a capacity of 750 kg distributed load (500 kg. with wheels). The working height is 700 - 970 mm without table top. For table tops with a width of 2500 mm, we recommend the use of 3 leg stands.



- Design the workplace according to your needs

GBP

Legs for 40mm tabletop

Highly stable legrests, designed for use with our 40mm tabletops. The leg trestles are delivered individually, for plate depth 600 / 620 mm respectively. 800 mm, and has a capacity of 750 kg distributed load (500 kg. with wheels). The working height is 700 - 970 mm without table top. For table tops with a width of 2500 mm, we recommend the use of 3 leg stands.

Height adjustment	Manual
Max. load (kg)	750
Colour	Grey RAL7004

	Working height excl. table top (mm)	SKU	Price
Adjustable, for tabletop depth 600 & 620mm	699 - 970	634479	*
Adjustable, for tabletop depth 800mm	700 - 970	634484	*
With wheels, for table top depth 800mm	655 - 940	635712	*

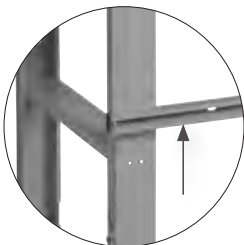

Body frame for leg trestles

If you want to build on your workshop tables with heavy trestles, order an attachment frame adapted to the desired table width. These frames have flexible, lateral attachment of vertical columns for accessories and are therefore suitable for all our accessories.

	SKU	Price
Width 1200 mm	636239	*
Width 1500 mm	634474	*
Width 2000 mm	634476	*
Width 2500 mm	634465	*



Steel undershelf for heavy leg trestles

Steel shelf with depth 350 mm, for mounting under tables with heavy trestles. Max load 200 kg for shelves up to 1500 mm, 100 kg for longer shelves. Painted in light grey RAL7004.

	SKU	Price
1372 x 350	636133	*
1072 x 350	636138	*
1872 x 350	636160	*



Wheelset for heavy leg trestles

Wheel set consisting of 4 swivelling Ø125 mm wheels, 2 of which have brakes. With the castors, the working height of the table increases by 150 mm and the capacity of the table is reduced to 280 kg distributed load.

	SKU	Price
4 pcs wheels	636342	*



HPL

Tabletop 40mm Light Grey - High pressure laminate

40 mm worktops with top in grey high-pressure laminate (HPL) edged with dark grey ABS edging. The HPL surface provides a table top with high scratch resistance and is resistant to liquids and chemicals. The worktops are pre-drilled with screw inserts for our heavy leg trestles and drawer sections, and consist of chipboard and laminated fibreboard.

	SKU	Price
1200 x 800	636437	*
1500 x 800	636438	*
2000 x 800	636439	*
2500 x 800	636440	*
1200 x 620	636441	*
1500 x 620	636442	*
2000 x 620	636443	*
2500 x 620	636444	*

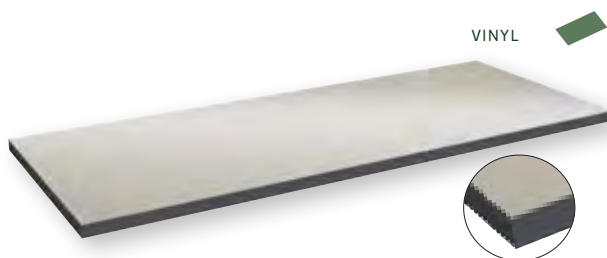

VINYL

Tabletop 40mm Light Grey - Vinyl

This is a 40 mm thick, popular all-round table top with a grey vinyl surface edged with dark grey ABS edging. The table top has some limited resistance to the strongest solvents, but is suitable for packaging and assembly work, for example. The worktops are pre-drilled with screw inserts for our heavy leg trestles and drawer sections, and consist of chipboard and laminated fibreboard.

	SKU	Price
1200 x 800	636445	*
1500 x 800	636447	*
2000 x 800	636448	*
2500 x 800	636449	*



OAK

Tabletop 40mm Oak

A beautiful and very popular table top with oak parquet surface, the front edge is anodized aluminum. Back and sides are dark grey ABS. The worktops are pre-drilled with screw inserts for our heavy leg trestles and drawer sections, and consist of chipboard and laminated fibreboard.

	SKU	Price
1200 x 800	636433	*
1500 x 800	636434	*
2000 x 800	636435	*
2500 x 800	636436	*

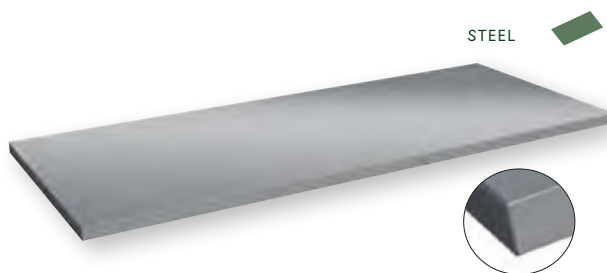

STEEL

Tabletop 40mm Steel

This is a 40 mm thick tabletop with a steel surface, the side edges are dark grey ABS edging. The steel surface covers the front and rear edges of the tabletop and is also pulled under the front edge for maximum durability. The table surface consists of a 1.5mm thick, electro-galvanized steel plate, which makes it very suitable for heavier workshop work. The worktops are pre-drilled with screw inserts for our heavy leg trestles and drawer sections, and consist of chipboard and laminated fibreboard.

	SKU	Price
1500 x 800	636474	*
2000 x 800	636475	*
2500 x 800	636476	*

Under shelf 40 mm

Heavy-duty leg rack, 40mm top side table tops in grey high-pressure laminate (HPL) edged with blue ABS trim. The HPL surface provides a table top with high scratch resistance and is resistant to liquids and chemicals. Capacity is 40 kg distributed load.



HPL

	SKU	Price
1200 x 585	638087	*
1500 x 585	638088	*
2000 x 585	638089	*



Fast edge/stop strip for 40 mm table tops

90 mm high stop strip in aluzinc finish, for mounting on the edge of a 40 mm table top.

Width (mm)	SKU	Price
1200	113759	*
1500	113760	*
2000	113761	*
2500	113762	*

*) Contact Sono for prices

Lightweight work tables

Lightweight workbench, also called H-stand, is designed for use with 24mm tabletops. The stand is supplied complete (without table top) and consists of 2 leg pairs of square tubes 35 x 35 x 2 mm, frame for stiffening the table top and attachment frame for building accessories at the rear edge of the table. The H-stand is adjustable and provides a working height of 700 - 950 mm (without tabletop). With wheels, the working height is 835 - 1075 mm. Capacity is 150 kg distributed load.

- For lighter needs
- Flexible
- Capacity 150 kg
- Wide range of items



150



Specifications

- Maximum load: 150 kg evenly distributed
- Manual height adjustment without table top: 700-950 mm
- Manual height adjustment without table top, including castors: 835-1075 mm

GBP

Complete the table!

Build your complete work table with drawer sections, bodywork and accessories. View from page 48.

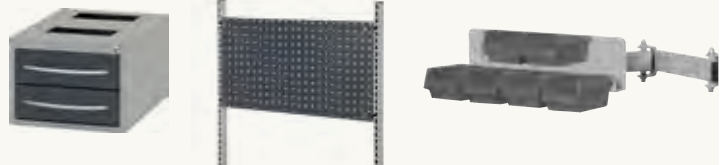

HPL



Lightweight workbench w/HPL tabletop

Complete workbench including H-stand and 24mm tabletop with grey HPL finish. The HPL surface provides a table top with high scratch resistance and is resistant to liquids and chemicals. Capacity is 150 kg distributed load and working height is 724 - 974 mm incl. table top.

Working height excl. table top (mm)	700 - 950
Load (kg)	150
Table top surface	High pressure laminate
Table top thickness (mm)	24
Border colour	Mocha grey
Undercarriage Color	Grey RAL7004

	SKU	Price
1200 x 620	636874	*
1500 x 620	636875	*
2000 x 620	636731	*
2500 x 620	636854	*
1200 x 800	636801	*
1500 x 800	636876	*
2000 x 800	636733	*
2500 x 800	636856	*

VINYL



Lightweight work table w/vinyl tabletop

Complete workbench including H-stand and 24mm tabletop with grey vinyl finish. Vinyl is a popular all-round tabletop for e.g. packing and assembly work, but with limited resistance to solvents. Capacity is 150 kg distributed load and working height is 724 - 974 mm incl. table top.

Working height excl. table top (mm)	700 - 950
Load (kg)	150
Table top surface	High pressure laminate
Table top thickness (mm)	24
Border colour	Mocha grey
Undercarriage Color	Grey RAL7004

	SKU	Price
1200 x 800	636729	*
1500 x 800	636690	*
2000 x 800	636736	*

HPL



Lightweight Work Table - Combination 1

Complete workbench including H-stand, 24mm tabletop with grey HPL surface and under shelf. The HPL surface provides a table top with high scratch resistance and is resistant to liquids and chemicals. Capacity is 150 kg distributed load and working height is 724 - 974 mm incl. table top.

Working height excl. table top (mm)	700 - 950
Load (kg)	150
Table top surface	High pressure laminate
Table top thickness (mm)	24
Border colour	Mocha grey
Undercarriage Color	Grey RAL7004

	SKU	Price
1500 x 800	636857	*
2000 x 800	636737	*

HPL



Lightweight Work Table - Combination 2

Complete workbench including H-stand, 24mm tabletop with grey HPL surface, suspension rails and adjustable shelves. The HPL surface provides a table top with high scratch resistance and is resistant to liquids and chemicals. Capacity is 150 kg distributed load and working height is 724 - 974 mm incl. table top. Stock boxes are ordered separately, depending on the desired size and quantity.

Working height excl. table top (mm)	700 - 950
Load (kg)	150
Table top surface	High pressure laminate
Table top thickness (mm)	24
Border colour	Mocha grey
Undercarriage Color	Grey RAL7004

	SKU	Price
1500 x 800	636692	*
2000 x 800	636858	*
2500 x 800	636701	*



HPL



Lightweight Work Table - Combination 5

Complete work table including H-stand, 24 mm table top with HPL surface, attachment kit with two shelves and two tool panels and tool tray with 3 drawers. Capacity is 150 kg distributed load and working height is 724 - 974 mm incl. table top.

Working height excl. table top (mm)	700 - 950	
Load (kg)	150	
Table top surface	High pressure laminate	
Table top thickness (mm)	24	
Border colour	Mocha grey	
Undercarriage Color	Grey RAL7004	
	SKU	Price
1500 x 800	636686	*



HPL



Lightweight Work Table - Combination 6

Complete work table including H-stand, 24 mm table top with HPL surface, attachment kit with two shelves, tool panel, electric rail, suspension strip with 6 red plastic boxes, light fixture LED, as well as tool tray with 2 drawers. Capacity is 150 kg distributed load and working height is 724 - 974 mm incl. table top.

Working height excl. table top (mm)	700 - 950	
Load (kg)	150	
Table top surface	High pressure laminate	
Table top thickness (mm)	24	
Border colour	Mocha grey	
Undercarriage Color	Grey RAL7004	
	SKU	Price
1500 x 800	636725	*



HPL



Lightweight Work Table - Combination 4

Complete workbench including H-stand, 24mm tabletop with grey HPL surface, one tool plate, suspension rail and two adjustable shelves. The HPL surface provides a table top with high scratch resistance and is resistant to liquids and chemicals. Capacity is 150 kg distributed load and working height is 724 - 974 mm incl. table top. Stock boxes are ordered separately, depending on the desired size and quantity.

Working height excl. table top (mm)	700 - 950	
Load (kg)	150	
Table top surface	High pressure laminate	
Table top thickness (mm)	24	
Border colour	Mocha grey	
Undercarriage Color	Grey RAL7004	
	SKU	Price
1500 x 800	636738	*
2000 x 800	636859	*
2500 x 800	636702	*



HPL



Lightweight Work Table - Combination 3

Complete workbench including H-stand, 24mm tabletop with grey HPL surface, two tool plates, suspension rail and adjustable shelf. The HPL surface provides a table top with high scratch resistance and is resistant to liquids and chemicals. Capacity is 150 kg distributed load and working height is 724 - 974 mm incl. table top. Stock boxes are ordered separately, depending on the desired size and quantity.

Working height excl. table top (mm)	700 - 950	
Load (kg)	150	
Table top surface	High pressure laminate	
Table top thickness (mm)	24	
Border colour	Mocha grey	
Undercarriage Color	Grey RAL7004	
	SKU	Price
1500 x 800	636693	*
2500 x 800	636730	*
2000 x 800	636877	*

Build your own desk

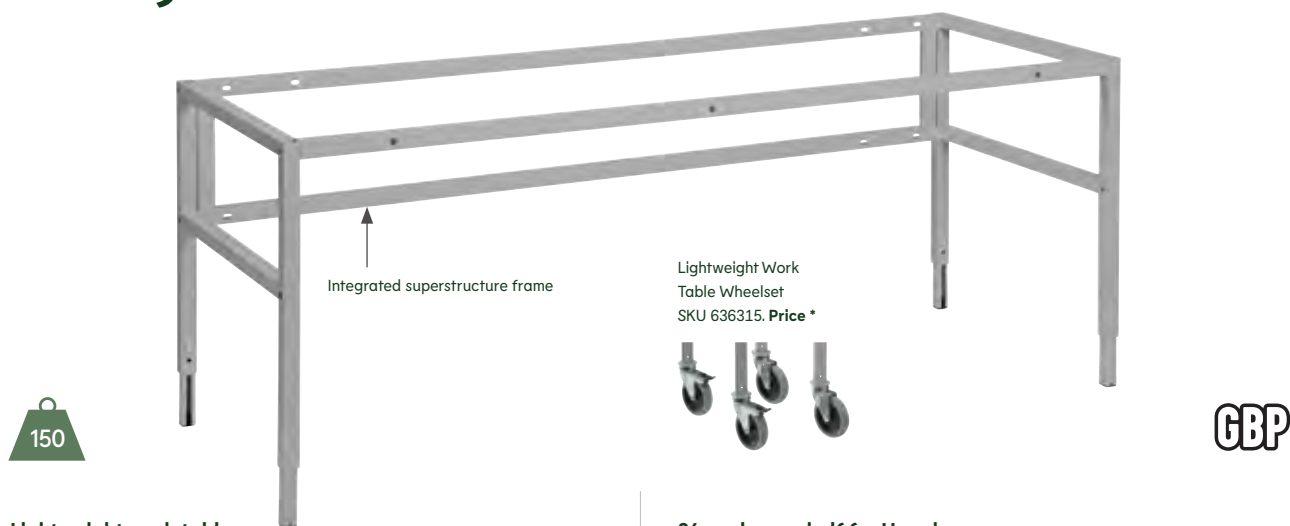

Lightweight work table

Lightweight workbench, also called H-stand, is designed for use with 24mm tabletops. The stand is supplied complete (without table top) and consists of 2 leg pairs of square tubes 35 x 35 x 2 mm, frame for stiffening the table top and attachment frame for building accessories at the rear edge of the table. The H-stand is adjustable and provides a working height of 700 - 950 mm (without tabletop). With wheels, the working height is 835 - 1075 mm. Capacity is 150 kg distributed load.

Attachment frame	Included
Load (kg)	150
Undercarriage Color	Grey RAL7004
Undercarriage material	Steel pipe
Chassis dimension (mm)	35 x 35 x 2

	Chassis dimension (mm)	SKU	Price
800 x 620 mm	790 x 585	636719	*
1200 x 620 mm	1090 x 585	636718	*
1500 x 620 mm	1490 x 585	636802	*
2000 x 620 mm	1990 x 585	636695	*
2500 x 620 mm	2490 x 585	636873	*
800 x 800 mm	790 x 765	636704	*
1200 x 800 mm	1090 x 765	636724	*
1500 x 800 mm	1490 x 765	636855	*
2000 x 800 mm	1990 x 785	636735	*
2500 x 800 mm	2490 x 765	636726	*

24mm lower shelf for H rack

24 mm bottom shelf with top in grey HPL edged with dark grey ABS edging. The HPL surface provides a table top with high scratch resistance and is resistant to liquids and chemicals. Capacity is 50 kg distributed load.

Tabletop color	Light Grey
Table plate	High pressure laminate
Border	Dark Grey
Max. load evenly distributed (kg)	50

	SKU	Price
1500 x 585	636466	*
2000 x 585	636467	*



Tabletop 24 mm High pressure laminate

24 mm tabletop with top in grey high-pressure laminate (HPL) edged with dark grey ABS edging. The HPL surface provides a table top with high scratch resistance and is resistant to liquids and chemicals. The table top is adapted for use with the H-stand, Table 400, ErgoMini and ErgoMulti.

	SKU	Price
800 x 620	636429	*
1200 x 620	636477	*
1500 x 620	636430	*
2000 x 620	636431	*
2500 x 620	636432	*
800 x 800	636425	*
1200 x 800	636446	*
1500 x 800	636426	*
2000 x 800	636427	*
2500 x 800	636428	*



Tabletop 24 mm Vinyl

24 mm tabletop with grey vinyl surface, edged with dark grey ABS edging. The vinyl surface gives a table top with a slightly softer expression and high impact resistance. The table top is adapted for use with the H-stand, Table 400, ErgoMini and ErgoMulti.

	SKU	Price
1200 x 800	636455	*
1500 x 800	636456	*
2000 x 800	636457	*

ErgoMini motorised chassis

The chassis consists of 2 table legs – with integrated motor in each leg – paired with spacers for increased stability. In addition, the chassis includes a sturdy top frame that ensures stability also in the table top. The chassis has a capacity of 180 kg and lifts 20 mm/s without load. The 450 mm stroke provides optimum working height of 710 – 1160 mm (without tabletop). Attachment frame for vertical columns and accessories to be ordered separately.

- Stable & Agile
- Capacity 180 kg
- Wide range of items



Specifications

- Maximum load 180 kg evenly distributed
- No-load speed: 20 mm/sek
- Electric height adjustment without table top: 710-1160 mm

GBP

Complete the table!

Build your complete work table with drawer sections, bodywork and accessories. View from page 48.





VINYL / HPL

ErgoMini table w/vinyl table top

Complete ErgoMini work table with electrically adjustable working height, including 24 mm grey vinyl table top. Vinyl is a popular all-rounder, e.g. for packing and light assembly work. The table has a capacity of 180 kg distributed load and lifts 20 mm/s without load.

Working height excl. table top (mm)	710 - 1160
Load (kg)	180
Lifting speed (mm/sec)	20
Tabletop color	Light Grey
Table top surface	Vinyl
Table top thickness (mm)	24
Border colour	Dark Grey
Undercarriage Color	Aluminium grey RAL9006

	SKU	Price
1200 x 800	636974	*
1500 x 800	637006	*
2000 x 800	637001	*

ErgoMini table w/HPL table top

Complete ErgoMini desk with electrically adjustable working height, including 24 mm grey HPL worktop. The HPL surface provides a table top with high scratch resistance and is resistant to liquids and chemicals. The table has a capacity of 180 kg distributed load and lifts 20 mm/s without load.

Working height excl. table top (mm)	710 - 1160
Load (kg)	180
Lifting speed (mm/sec)	20
Tabletop color	Light Grey
Table top surface	High pressure laminate
Table top thickness (mm)	24
Border colour	Dark Grey
Undercarriage Color	Aluminium grey RAL9006

	SKU	Price
1200 x 620	636939	*
1500 x 620	637011	*
2000 x 620	636983	*
1200 x 800	636973	*
1500 x 800	636986	*
2000 x 800	637005	*



HPL

ErgoMini worktable - combination 1

Complete ErgoMini worktable with electrically adjustable working height, including 24 mm grey HPL table top and extension with tool board and adjustable shelf. The HPL surface provides a table top with high scratch resistance and is resistant to liquids and chemicals. The table has a capacity of 180 kg distributed load and lifts 20 mm/s without load.

Working height excl. table top (mm)	710 - 1160
Load (kg)	180
Lifting speed (mm/sec)	20
Tabletop color	Light Grey
Table top surface	High pressure laminate
Table top thickness (mm)	24
Border colour	Dark Grey
Undercarriage Color	Aluminium grey RAL9006

	SKU	Price
1200 x 800	636889	*
1500 x 800	636821	*
2000 x 800	636890	*



ErgoMini worktable - combination 2

Complete ErgoMini desk with electrically adjustable working height, including 24 mm grey HPL table top and extension. The superstructure consists of 2 adjustable shelves, tool board, 3 suspension rails, monitor and keyboard holder and binder holder. The HPL surface provides a table top with high scratch resistance and is resistant to liquids and chemicals. The table has a capacity of 180 kg distributed load and lifts 20 mm/s without load. Module boxes as shown are ordered separately, depending on the desired size and quantity.

Working height excl. table top (mm)	710 - 1160
Load (kg)	180
Lifting speed (mm/sec)	20
Tabletop color	Light Grey
Table top surface	High pressure laminate
Table top thickness (mm)	24
Border colour	Dark Grey
Undercarriage Color	Aluminium grey RAL9006
	SKU Price
1500 x 800	636930 *
2000 x 800	636845 *



ErgoMini worktable - combination 3

Complete ErgoMini desk with electrically adjustable working height, including 24 mm grey HPL table top and extension. The superstructure consists of adjustable shelf, tool board, whiteboard, 2 suspension rails, monitor and keyboard holder and retractable box shelf. The HPL surface provides a table top with high scratch resistance and is resistant to liquids and chemicals. The table has a capacity of 180 kg distributed load and lifts 20 mm/s without load. Module boxes as shown are ordered separately, depending on the desired size and quantity.

Working height excl. table top (mm)	710 - 1160
Load (kg)	180
Lifting speed (mm/sec)	20
Tabletop color	Light Grey
Table top surface	High pressure laminate
Table top thickness (mm)	24
Border colour	Dark Grey
Undercarriage Color	Aluminium grey RAL9006
	SKU Price
1500 x 800	636969 *
2000 x 800	636822 *

Build your own desk



ErgoMini motorised chassis



Wheel set for ErgoMini and ErgoNomi

Wheel sets for ErgoMini and ErgoNomi desks are complete and consist of 4 double, lockable castors with Ø75 mm diam. Height 99 mm, bolt diameter 10 mm.

SKU: 573725 Price *

180

ErgoMini motorised chassis

The chassis consists of 2 table legs - with integrated motor in each leg - paired with spacers for increased stability. In addition, the chassis includes a sturdy top frame that ensures stability also in the table top. The chassis has a capacity of 180 kg and lifts 20 mm/s without load. The 450 mm stroke provides optimum working height of 710 - 1160 mm (without tabletop). Attachment frame for vertical columns and accessories to be ordered separately.

Attachment frame	Not Included
Working height excl. table top (mm)	710 - 1160
Load (kg)	180
Undercarriage material	Steel pipe
Chassis dimension (mm)	50 x 70

	Chassis dimension (mm)	SKU	Price
1200 x 620 mm	1080 x 580	637008	*
1500 x 620 mm	1480 x 580	637009	*
2000 x 620 mm	1980 x 580	636991	*
2500 x 620 mm	2480 x 580	637028	*
1200 x 800 mm	1080 x 780	637021	*
1500 x 800 mm	1480 x 780	637022	*
2000 x 800 mm	1980 x 780	636972	*
2500 x 800 mm	2480 x 780	636987	*

Attachment frame for ErgoMini

For the attachment at the rear edge of the ErgoMini work table, the attachment frame is ordered according to the desired table width. These frames have flexible, lateral attachment of vertical columns for accessories and are therefore suitable for all our accessories.

	SKU	Price
Width 1200 mm	301406	*
Width 1500 mm	301407	*
Width 2000 mm	301408	*
Width 2500 mm	417300	*

Undershelf 24 mm - for ErgoMini

Undershelf for ErgoMini, 24 mm tabletops with top in grey high-pressure laminate (HPL) edged with dark grey ABS edging. The HPL surface provides a table top with high scratch resistance and is resistant to liquids and chemicals. Capacity is 50 kg distributed load.



	SKU	Price
1500 x 350	636966	*
2000 x 350	636967	*



Tabletop 24 mm High pressure laminate

24 mm tabletop with top in grey high-pressure laminate (HPL) edged with dark grey ABS edging. The HPL surface provides a table top with high scratch resistance and is resistant to liquids and chemicals. The table top is adapted for use with the H-stand, Table 400, ErgoMini and ErgoMulti.

	SKU	Price
1200 x 620	636477	*
1500 x 620	636430	*
2000 x 620	636431	*
2500 x 620	636432	*
1200 x 800	636446	*
1500 x 800	636426	*
2000 x 800	636427	*
2500 x 800	636428	*

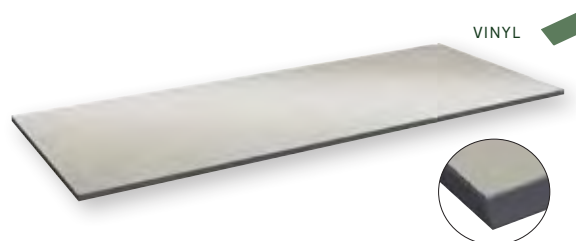

Tabletop 24 mm Vinyl

24 mm tabletop with grey vinyl surface, edged with dark grey ABS edging. The vinyl surface gives a table top with a slightly softer expression and high impact resistance. The table top is adapted for use with the H-stand, Table 400, ErgoMini and ErgoMulti.

	SKU	Price
1200 x 800	636455	*
1500 x 800	636456	*
2000 x 800	636457	*

Table 400 – Motorised workbenches

Table 400 is a sturdy table that is made for tough requirements in the industry. Here we have emphasized ergonomics and productivity. The table has electrically stepless adjustable legs that are adapted to the user's needs and work tasks. It can be assembled with up to 4 legs in total (a length of 7.5 m). The capacity of the table is regular lifting of evenly distributed 400 kg. The table has an ergonomic L-foot solution, with an attached basic frame that allows for a wide range of accessories. Without load, the lifting speed is 13 mm/s – working height is 685 – 1085 mm, without table top. The table 400 chassis is intended for use with our 24 mm table tops (to be ordered separately) and includes the control box and standard hand control TH14.

- For heavier needs
- Capacity 400 kg
- Stable & Agile



GBP



Specifications

- Maximum load: 400 kg evenly distributed
- No-load speed: 13 mm/sek
- Electric height adjustment without table top: 685–1085 mm

Complete the table!

Build your complete work table with drawer sections, bodywork and accessories. View from page 48.





Table 400 m/HPL table top

Complete Table 400 with electrically adjustable working height 710 - 1110 mm, including 24 mm grey HPL tabletop. The HPL surface provides a high scratch resistant tabletop that is resistant to liquids and chemicals. The table has a capacity of 400 kg and lifts 13 mm/s without load.

Load (kg)	400
Lifting speed (mm/sec)	13
Tabletop color	Light Grey
Table top surface	High pressure laminate

	SKU	Price
1200 x 620	636880	*
1500 x 620	636688	*
2000 x 620	636809	*
2500 x 620	636910	*
1200 x 800	636831	*
1500 x 800	636805	*
2000 x 800	636949	*
2500 x 800	636747	*



Table 400 m/vinyl tabletop

Complete Table 400 with electrically adjustable working height 710 - 1110 mm, including 24 mm grey vinyl tabletop. Vinyl is a popular all-round tabletop for e.g. packing and assembly work, but with some limited resistance to solvents. The table has a capacity of 400 kg and lifts 13 mm/s without load.

Load (kg)	400
Lifting speed (mm/sec)	13
Tabletop color	Light Grey
Table top surface	Vinyl

	SKU	Price
1200 x 800	636942	*
1500 x 800	636806	*
2000 x 800	636906	*



Table 400 - Combination 1

Complete Table 400 with electrically adjustable working height 710 - 1110 mm, including 24 mm grey HPL table top and attachment section with 1 tool board, 1 suspension strip and 2 adjustable shelves. The HPL surface provides a table top with high scratch resistance and is resistant to liquids and chemicals. The table has a capacity of 400 kg and lifts 13 mm/s without load.

Load (kg)	400
Lifting speed (mm/sec)	13
Tabletop color	Light Grey
Table top surface	High pressure laminate

	SKU	Price
1500 x 800	636807	*
2000 x 800	636907	*
2500 x 800	636749	*



Table 400 - Combination 2

Complete Table 400 with electrically adjustable working height 710 - 1110 mm, including 24 mm grey HPL table top and attachment section with 2 tool boards, 1 suspension strip and 1 adjustable shelf. The HPL surface provides a table top with high scratch resistance and is resistant to liquids and chemicals. The table has a capacity of 400 kg and lifts 13 mm/s without load.

Load (kg)	400
Lifting speed (mm/sec)	13
Tabletop color	Light Grey
Table top surface	High pressure laminate

	SKU	Price
1500 x 800	636764	*
2000 x 800	636908	*
2500 x 800	636815	*

*) Contact Sono for prices



GBP

Table 400 - Combination 3

Complete Table 400 with electrically adjustable working height 710 - 1110 mm, including 24 mm grey HPL table top and attachment section with 2 tool boards, 1 suspension strip and 2 adjustable shelves. The HPL surface provides a table top with high scratch resistance and is resistant to liquids and chemicals. The table has a capacity of 400 kg and lifts 13 mm/s without load. Module boxes depicted (types 2074 and 2075) are not included and are ordered separately.

Load (kg)	400
Lifting speed (mm/sec)	13
Tabletop color	Light Grey
Table top surface	High pressure laminate

	SKU	Price
1500 x 800 mm	636882	•
2000 x 800 mm	636745	•
2500 x 800 mm	636816	•

Build your own desk



Hand controller TH14

Table 400 Wheelset

To make your workspaces with Table 400 even more flexible, order this wheelset. The set is complete and consists of 4 double lockable castors with Ø75mm diameter.

SKU	Price
302255	*



Table 400 - Motorised workbenches

Table 400 is a sturdy table that is made for tough requirements in the industry. Here we have emphasized ergonomics and productivity. The table has electrically stepless adjustable legs that are adapted to the user's needs and work tasks. It can be assembled with up to 4 legs in total (a length of 7.5 m). The capacity of the table is regular lifting of evenly distributed 400 kg. The table has an ergonomic L-foot solution, with an attached basic frame that allows for a wide range of accessories. Without load, the lifting speed is 13 mm/s - working height is 685 - 1085 mm, without table top. The table 400 chassis is intended for use with our 24 mm table tops (to be ordered separately) and includes the control box and standard hand control TH14.

	Chassis dimension (mm)	SKU	Price
1200 x 620 mm	1120 x 560 mm	636800	*
1500 x 620 mm	1420 x 560 mm	636905	*
2000 x 620 mm	1920 x 560 mm	636909	*
2500 x 620 mm	2420 x 560 mm	636818	*
1200 x 800 mm	1120 x 760 mm	636904	*
1500 x 800 mm	1420 x 760 mm	636836	*
2000 x 800 mm	1920 x 760 mm	636950	*
2500 x 800 mm	2420 x 760 mm	636817	*

24 mm table tops 400



Tabletop 24 mm High pressure laminate

24 mm tabletop with top in grey high-pressure laminate (HPL) edged with dark grey ABS edging. The HPL surface provides a table top with high scratch resistance and is resistant to liquids and chemicals. The table top is adapted for use with the H-stand, Table 400, ErgoMini and ErgoMulti.

	SKU	Price
1200 x 620	636477	*
1500 x 620	636430	*
2000 x 620	636431	*
2500 x 620	636432	*
1200 x 800	636446	*
1500 x 800	636426	*
2000 x 800	636427	*
2500 x 800	636428	*



Tabletop 24 mm Vinyl

24 mm tabletop with grey vinyl surface, edged with dark grey ABS edging. The vinyl surface gives a table top with a slightly softer expression and high impact resistance. The table top is adapted for use with the H-stand, Table 400, ErgoMini and ErgoMulti.

	SKU	Price
1200 x 800	636455	*
1500 x 800	636456	*
2000 x 800	636457	*

ErgoMulti motorised workbenches

ErgoMulti is an electrically powered base, which together with our 24 mm table tops provides an optimal height-adjustable table for use in workshops, laboratories or other contexts where ergonomic and flexibility requirements are prioritised. The chassis consists of extruded aluminium legs, whose wide profile and location ensure that both stability and legroom are optimal in the workplace. The smooth and conformal construction gives the table a smooth and complete surface that makes it easy to keep everything clean and hygienic. The chassis has a capacity of 250 kg and lifts 20 mm/s without load. The 450 mm stroke provides optimum working height of 685 – 1135 mm (without tabletop). The chassis comes complete with combined cable shelter and attachment frame adapted to our wide range of accessories.

- Stability & Design
- Capacity 250 kg
- Fast raise-lower function
- Extra High Stroke



Specifications

- Maximum load: 250 kg evenly distributed
- No-load speed: 20 mm/sek
- Electric height adjustment without table top: 685-1135 mm
- Integrated superstructure frame

GBP

Complete the table!

Build your complete work table with drawer sections, bodywork and accessories. View from page 48.





HPL

ErgoMulti work table w/HPL table top

Complete ErgoMulti desk with electrically adjustable working height, including 24 mm grey HPL worktop. The HPL surface provides a table top with high scratch resistance and is resistant to liquids and chemicals. The chassis has a capacity of 250 kg and lifts 20 mm/s without load.

Working height excl. table top (mm)	685 - 1135
Load (kg)	250
Lifting speed (mm/sec)	20
Tabletop color	Light Grey
Table top surface	High pressure laminate

	SKU	Price
1200 x 800	637043	*
1500 x 800	637034	*
2000 x 800	637035	*



VINYL

ErgoMulti work table w/vinyl table top

Complete ErgoMulti work table with electrically adjustable working height, including 24 mm grey vinyl table top. Vinyl is a popular all-round tabletop for e.g. packing and assembly work, but with limited resistance to solvents. The chassis has a capacity of 250 kg and lifts 20 mm/s without load.

Working height excl. table top (mm)	685 - 1135
Load (kg)	250
Lifting speed (mm/sec)	20
Tabletop color	Light Grey
Table top surface	High pressure laminate

	SKU	Price
1200 x 800	637040	*
1500 x 800	637044	*
2000 x 800	637019	*



HPL

ErgoMulti worktable - combination 1

Complete ErgoMulti work table with electrically adjustable working height, including 24 mm grey HPL table top, 3 suspension strips and 3 adjustable shelves. The HPL surface provides a table top with high scratch resistance and is resistant to liquids and chemicals. The chassis has a capacity of 250 kg and lifts 20 mm/s without load. Module boxes are ordered separately, depending on the desired size and quantity.

Working height excl. table top (mm)	685 - 1135
Load (kg)	250
Lifting speed (mm/sec)	20
Tabletop color	Light Grey
Table top surface	High pressure laminate

	SKU	Price
1500 x 800	636781	*
2000 x 800	636888	*



HPL

ErgoMulti worktable - combination 2

Complete ErgoMulti work table with electrically adjustable working height, including 24 mm grey HPL table top, tool board, pull-out bookshelf, suspension strip and 2 adjustable shelves. The HPL surface provides a table top with high scratch resistance and is resistant to liquids and chemicals. The chassis has a capacity of 250 kg and lifts 20 mm/s without load. Module boxes are ordered separately, depending on the desired size and quantity.

Working height excl. table top (mm)	685 - 1135
Load (kg)	250
Lifting speed (mm/sec)	20
Tabletop color	Light Grey
Table top surface	High pressure laminate

	SKU	Price
1500 x 800	636791	*
2000 x 800	636710	*

*) Contact Sono for prices



HPL

ErgoMulti worktable - combination 3

Complete ErgoMulti desk with electrically adjustable working height, including 24 mm grey HPL table top, tool board, whiteboard, pull-out bookshelf, hanging strip, shelf and binder holder. The HPL surface provides a table top with high scratch resistance and is resistant to liquids and chemicals. The chassis has a capacity of 250 kg and lifts 20 mm/s without load. Module boxes are ordered separately, depending on the desired size and quantity.

Working height excl. table top (mm)	685 - 1135
Load (kg)	250
Lifting speed (mm/sec)	20
Tabletop color	Light Grey
Table top surface	High pressure laminate
Table top thickness (mm)	24

	SKU	Price
1500 x 800	636932	*
2000 x 800	636820	*



HPL

ErgoMulti worktable - combination 4

Complete ErgoMulti work table with electrically adjustable working height, including 24 mm grey HPL table top, tool board, whiteboard, pull-out bookshelf, hanging strip and shelf. The HPL surface provides a table top with high scratch resistance and is resistant to liquids and chemicals. The chassis has a capacity of 250 kg and lifts 20 mm/s without load. Module boxes are ordered separately, depending on the desired size and quantity.

Working height excl. table top (mm)	685 - 1135
Load (kg)	250
Lifting speed (mm/sec)	20
Tabletop color	Light Grey
Table top surface	High pressure laminate
Table top thickness (mm)	24

	SKU	Price
1500 x 800	636993	*
2000 x 800	636844	*

Build your own desk



2 powerful lowering motors ensure optimum working position. Integrated attachment frame and cable shelter – for a tidy and hygienic workspace.



ErgoMulti motorised workbenches

ErgoMulti is an electrically powered base, which together with our 24 mm table tops provides an optimal height-adjustable table for use in workshops, laboratories or other contexts where ergonomic and flexibility requirements are prioritised. The chassis consists of extruded aluminium legs, whose wide profile and location ensure that both stability and legroom are optimal in the workplace. The smooth and conformal construction gives the table a smooth and complete surface that makes it easy to keep everything clean and hygienic. The chassis has a capacity of 250 kg and lifts 20 mm/s without load. The 450 mm stroke provides optimum working height of 685 – 1135 mm (without tabletop). The chassis comes complete with combined cable shelter and attachment frame adapted to our wide range of accessories.

	Chassis dimension (mm)	SKU	Price
1200 x 800 mm	960 x 750	301400	*
1500 x 800 mm	1360 x 750	301401	*
2000 x 800 mm	1860 x 750	301402	*
Wheelset 4 pcs. lockable Ø75 mm		302260	*

24 mm table tops ERGOMULTI



Tabletop 24 mm High pressure laminate

24 mm tabletop with top in grey high-pressure laminate (HPL) edged with dark grey ABS edging. The HPL surface provides a table top with high scratch resistance and is resistant to liquids and chemicals. The table top is adapted for use with the H-stand, Table 400, ErgoMini and ErgoMulti.

	SKU	Price
1200 x 620	636477	*
1500 x 620	636430	*
2000 x 620	636431	*
2500 x 620	636432	*
1200 x 800	636446	*
1500 x 800	636426	*
2000 x 800	636427	*
2500 x 800	636428	*



Tabletop 24 mm Vinyl

24 mm tabletop with grey vinyl surface, edged with dark grey ABS edging. The vinyl surface gives a table top with a slightly softer expression and high impact resistance. The table top is adapted for use with the H-stand, Table 400, ErgoMini and ErgoMulti.

	SKU	Price
1200 x 800	636455	*
1500 x 800	636456	*
2000 x 800	636457	*

ErgoNomi workbenches with crank

Chassis for ErgoNomi crank table, for 24 mm table top. The working height is without tabletop and this is ordered separately. The table height is easily adjusted with a crank. The stand has an intermediate brace for increased stability and is prepared for an attachment frame to be ordered separately. Maximum capacity is 250 kg under evenly distributed load. With our wide range of accessories, the table stand can be adapted to most needs.

- Height adjustment without power
- Wide range of items



GBP



Wheel set for ErgoMini and ErgoNomi

Wheel sets for ErgoMini and ErgoNomi desks are complete and consist of 4 double, lockable castors with Ø75 mm diam. Height 99 mm, bolt diameter 10 mm. SKU 573725 . Price *



ErgoNomi workbenches with crank

Working height excl. table top (mm) : 710 - 1160

	Chassis dimension (mm)	SKU	Price
1200 x 800 mm	1080 x 780	637023	*
1500 x 800 mm	1480 x 780	637024	*
2000 x 800 mm	1980 x 780	636980	*

HPL



ErgoNomi table w/HPL table top

Complete ErgoNomi workbench where the working height is manually adjusted with crank, including 24-mm grey HPL tabletop. The HPL surface provides a table top with high scratch resistance and is resistant to liquids and chemicals. The table has a capacity of 250 kg evenly distributed load. Add-on frame for vertical columns and accessories to be ordered separately.

	Working height excl. table top (mm)	SKU	Price
1200 x 800	710 -1160	636999	*
1500 x 800	710 -1160	637010	*
2000 x 800	710 -1160	637000	*

VINYL



ErgoNomi table w/vinyl table top

Complete ErgoNomi work table where the working height is adjusted manually with crank, including 24 mm grey vinyl table top. Vinyl is a popular all-rounder, e.g. for packing and light assembly work. The table has a capacity of 250 kg evenly distributed load. Add-on frame for vertical columns and accessories to be ordered separately.

	Working height excl. table top (mm)	SKU	Price
1200 x 800	710 -1160	636941	*
1500 x 800	710 -1160	637020	*
2000 x 800	710 -1160	637004	*



ErgoSingle TL18 Workstation Chassis

The ErgoSingle TL18 workstation features a heavy-duty galvanized top and floor plate. Plate Dimensions: 495 x 495 x 8 mm. Height adjustment is made easy with 710 -1210 mm electric hand control, excluding tabletop. The column station should be bolted to the floor. It can be used standing loose on the floor, but must be secured so that it does not tip over. This also applies to the use of wheels. Table top (recommended size 800 x 600 mm), attachment frame and attachment equipment are ordered separately. The superstructure will be CC 670 mm.

Number of column	Single
Capacity (kg)	200
Recommended size table top (mm)	800 x 600 x 24 or 40
Working height excl. plate (mm)	710 - 1210
Lifting speed (mm/sec)	22

SKU	Price
436113	*



Wheelset, 4 pcs
lockable Ø75mm
SKU 396579
Price *

Bodywork frame for ErgoSingle

Attachment frame for ErgoSingle workstation. With the attachment frame, the ErgoSingle can easily be supplemented with more attachment details and it is adapted to CC 670 mm.

	SKU	Price
Width 800 mm	636705	*



Lifting column table TL18 Single, chassis

The table stand consists of a stable lifting column TL18 made of aluminum with integrated motor. The table height is easily adjusted with a hand control mounted under the table in the table frame. The table has a capacity of 200 kg distributed load and lifts 22 mm/s without load. The stand comes with an attachment frame as standard. Tabletop ordered separately.

	Working height excl. table top (mm)	SKU	Price
800 x 800	750 - 1250	636887	*
1200 x 800	750 - 1250	636881	*



Easy Work 8010 - Work and Assembly Table

Easy Work 8010 is a smooth and easy-to-use work and assembly table that is easily adjusted with gas lift. The table top is 500 x 350 mm, has a quick edge and is powder coated in RAL 5010. It can be angled 0-30°. The table has a capacity of 100 kg distributed load (25 kg when raised) and the working height (without table top) is 620 - 875 mm.

	SKU	Price
Easy Work 8010 - Work and Assembly Table	396530	*

Lifting columns

Heavy-duty, electrically powered, extruded aluminum lifting columns designed for workshop and industrial applications. Comes with control unit and is complemented by optional hand or foot control. Please contact us for engineering, calculation and quotes.



- High capacity
- Can be connected in series



Hand controller TFH3



Hand controller TDH5



Hand controller TH14



302341
575343
Mounting bracket for control box TL18



Foot control TFS3

Accessories for TL3 and TL18

The desired hand control must be selected for the lifting columns TL3 and TL18. We further recommend ordering bracket for attachment of control box (2 pcs for 4-parallel columns). For TL3, top and bottom plates must also be ordered, 2 pieces per column.

	SKU	Price
Hand controller TH14	301062	*
Hand controller TDH5	302058	*
Hand controller TFH3	302059	*
Foot control TFS3	302062	*
Mounting bracket for control box TL18	302341	*
Mounting bracket for control box TL3	575343	*
Upper and lower attachment plate	302342	*



Upper and lower attachment plate

TL18 Lifting columns, 500 mm electric drive

The TL18 is a heavy-duty, electrically powered extruded aluminium lifting column designed for use in the workshop and industry. You choose whether you want the outer profile up or down. Each column comes with a delayed floor and top plate (257 x 195 x 8 mm) for safe and steady operation, and has a working height of 670 - 1170 mm (without tabletop). Lifting speed is 22 mm/s without load and electronic control box is included, depending on the design. Select the desired control unit, hand or foot control. Columns are certified to standards IEC60601-1, ES60601-1, IEC60601-1-2, UL73 & EMC.

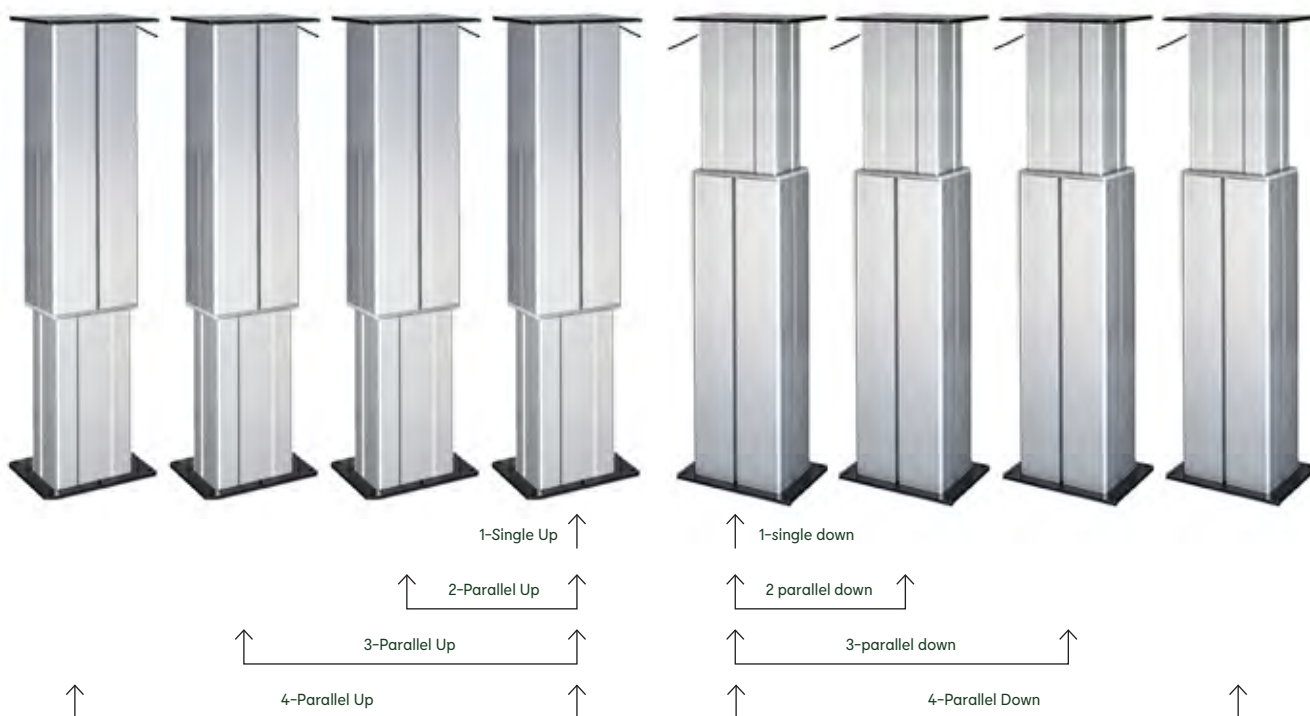

Max. load/column(N)	2000
Height range excl. plate (mm)	670 - 1170
Lifting speed (mm/sec)	22
Max. dynamic bending torque (Nm)	250
Max. static bending torque/column (Nm)	500

	Outer profile	Number of column	Capacity (kg)	SKU	Price
TL18-1-O	up	1-single	200	302233	*
TL18-2-O	up	2-Parallel	350	302234	*
TL18-3-O	up	3-Parallel	450	302235	*
TL18-4-O	up	4-Parallel	600	302236	*
TL18-1-N	down	1-single	200	302237	*
TL18-2-N	down	2-Parallel	350	302238	*
TL18-3-N	down	3-Parallel	450	302239	*
TL18-4-N	down	4-Parallel	600	302240	*



TL3 Lifting columns, 700 mm electric drive

The TL3 is a heavy-duty, electrically powered extruded aluminium lifting column designed for use in the workshop and industry. For each column, order 2 pieces of delayed floor and top plate (257 x 195 x 8 mm) for safe and steady operation. The table has working height 520 - 1220 mm (without table top). Lifting speed is 34 mm/s without load and electronic control box is included, depending on the design. Select the desired control unit, hand or foot control. The columns are certified according to standards IEC60601-1 & EMC.

	Capacity (kg)	Maximum Load/Column(N)	Max. dynamic bending torque (Nm)	Max. static bending torque/column (Nm)	SKU	Price
1-single	200	2000	1000	2000	302241	*
2-Parallel	350	2000	1000	2000	302242	*
3-Parallel	450	2000	1000	2000	302243	*
4-Parallel	600	2000	1000	2000	302244	*
					SKU	Price
Upper and lower attachment plate					302342	*

*) Contact Sono for prices

ESD Work Space

Electrically adjustable Table 400 ESD work table, including extension frame and with 24 mm table top. The worktop is grey ESD laminate or ESD linoleum, with solid wood edging and including earthing point on the underside of the worktop. The table is supplied with an earthing terminal with push buttons for ESD wristbands, an earthing contact with ring terminals and a terminal block. Stroke length is 250 mm and lifting speed is 13 mm/sec without load. The maximum load on the table is 400 kg, evenly distributed load. Working height is 724 - 794 mm including table top.

GBP



ESD worktable, Table 400

Electrically adjustable Table 400 ESD work table, including extension frame and with 24 mm table top. The worktop is grey ESD laminate or ESD linoleum, with solid wood edging and including earthing point on the underside of the worktop. The table is supplied with an earthing terminal with push buttons for ESD wristbands, an earthing contact with ring terminals and a terminal block. Stroke length is 250 mm and lifting speed is 13 mm/sec without load. The maximum load on the table is 400 kg, evenly distributed load. Working height is 724 - 794 mm including table top.

Border	Solid wood
Undercarriage Color	Aluminum
Undercarriage material	Aluminum
Chassis dimension (mm)	100x282
Earthing stud in worktop	Yes
Earthing terminal	3pcs 10mm push buttons
Earthing connector, length (m)	01.mai
Terminal block, connection	2 x M6 + 10 x M4

Table plate	Size (mm)	SKU	Price
	1200 x 800	636833	*
ESD laminate	1500 x 800	636808	*
	2000 x 800	636768	*
ESD linoleum	1200 x 800	636743	*
	1500 x 800	636883	*
	2000 x 800	636951	*



150

ESD work table Lightweight H-stand

Manually adjustable ESD work table with 24 mm table top. The worktop is grey ESD laminate or ESD linoleum, with solid wood edging and including earthing point on the underside of the worktop. The table is supplied with an earthing terminal with push buttons for ESD wristbands, an earthing contact with ring terminals and a terminal block. The maximum load on the table is 150 kg, evenly distributed load. Working height is 724 - 974 mm including table top.

Height adjustment	Manual
Border	Solid wood
Base colour	Grey-white
Undercarriage material	Steel pipe
Chassis dimension (mm)	35 x 35 x 2
Earthing stud in worktop	Yes
Earthing terminal	3pcs 10mm push buttons
Earthing connector, length (m)	01.mai
Terminal block, connection	2 x M6 + 10 x M4

Table plate	Size (mm)	SKU	Price
	1200 x 800	636878	*
ESD laminate	1500 x 800	636694	*
	2000 x 800	636739	*
	1200 x 800	636740	*
ESD linoleum	1500 x 800	636860	*
	2000 x 800	636813	*



250

ESD work table, ErgoNomi

Manually adjustable ErgoNomi ESD worktable, including add-on frame and with 24 mm table top. The worktop is grey ESD laminate or ESD linoleum, with solid wood edging and including earthing point on the underside of the worktop. The table is supplied with an earthing terminal with push buttons for ESD wristbands, an earthing contact with ring terminals and a terminal block. Stroke length is 450 mm and lifting speed is 2.5 mm/rev. The maximum load on the table is 250 kg, evenly distributed load. Working height is 734 - 1184 mm including table top.

Border	Solid wood
Undercarriage Color	Aluminum
Undercarriage material	Steel pipe
Chassis dimension (mm)	50x70
Earthing stud in worktop	Yes
Earthing terminal	3pcs 10mm push buttons
Earthing connector, length (m)	01.mai
Terminal block, connection	2 x M6 + 10 x M4

Table plate	Size (mm)	SKU	Price
	1200 x 800	636982	*
ESD laminate	1500 x 800	637002	*
	2000 x 800	636989	*
	1200 x 800	637003	*
ESD linoleum	1500 x 800	636990	*
	2000 x 800	637026	*



180

ESD worktable, ErgoMini

Electrically adjustable ErgoMini ESD worktable, including add-on frame and with 24 mm table top. The worktop is grey ESD laminate or ESD linoleum, with solid wood edging and including earthing point on the underside of the worktop. The table is supplied with an earthing terminal with push buttons for ESD wristbands, an earthing contact with ring terminals and a terminal block. Stroke length is 450 mm and lifting speed is 20 mm/sec without load. The maximum load on the table is 180 kg, evenly distributed load. Working height is 734 - 1184 mm including table top.

Border	Solid wood
Undercarriage Color	Aluminum
Undercarriage material	Steel pipe
Chassis dimension (mm)	50x70
Earthing stud in worktop	Yes
Earthing terminal	3pcs 10mm push buttons
Earthing connector, length (m)	01.mai
Terminal block, connection	2 x M6 + 10 x M4

Table plate	Size (mm)	SKU	Price
	1200 x 800	637025	*
ESD laminate	1500 x 800	636975	*
	2000 x 800	636968	*
	1200 x 800	636981	*
ESD linoleum	1500 x 800	636976	*
	2000 x 800	637007	*



250

ESD worktable, ErgoMulti

Electrically adjustable ErgoMulti ESD worktable, including add-on frame and with 24 mm table top. The worktop is grey ESD laminate or ESD linoleum, with solid wood edging and including earthing point on the underside of the worktop. The table is supplied with an earthing terminal with push buttons for ESD wristbands, an earthing contact with ring terminals and a terminal block. Stroke length is 450 mm and lifting speed is 20 mm/sec without load. The maximum load on the table is 250 kg, evenly distributed load. Working height is 709 - 1159 mm including table top.

Border	Solid wood
Undercarriage Color	Aluminum
Undercarriage material	Aluminum
Chassis dimension (mm)	70x290
Earthing stud in worktop	Yes
Earthing terminal	3pcs 10mm push buttons
Earthing connector, length (m)	01.mai
Terminal block, connection	2 x M6 + 10 x M4

Table plate	Size (mm)	SKU	Price
	1200 x 800	621399	*
ESD laminate	1500 x 800	621400	*
	2000 x 800	621401	*
	2000 x 800	621404	*
ESD linoleum	1200 x 800	621402	*
	1500 x 800	621403	*

Example of an ESD workspace containing the following:

- Workbench 400 with attachment frame
- 24 mm ESD table top including ESD table mat
- 3 perforated columns
- 2 suspension strips
- 3 ESD plastic boxes
- 2 intermediate struts
- 1 ESD bracelet
- 4 shelves with ESD mat

GBP



Attachment Kit BASIC

BASIC attachment kit for work tables and packing tables with perforated columns 1446 mm, spacers and mounting kit. Fits Light H, Workshop Bench, ErgoMini, ErgoNomi and Table 400.



	Total width (mm)	SKU	Price
CC 670	695	636866	*
CC 900	925	636846	*
CC 1375	1365	637041	*
CC 1800	1825	636937	*
2 x CC 670	1365	636793	*
2 x CC 900	1825	636823	*
CC 900 + 670	1595	636711	*
CC 1800 + 670	2035	637016	*
CC 1375 + 900	2265	636954	*
3 x CC 370	2035	636933	*
2 x CC 670 + CC 900	2265	636824	*

Basic add-on kit for ErgoMulti

Basic extension kit for worktables and packing tables with perforated columns 1446 mm, centre brace and mounting kit. Fits ErgoMulti.



	Total width (mm)	Qty	SKU	Price
CC 670	695	2	636867	*
CC 900	925	2	636955	*
CC 1375	1365	2	637032	*
CC 1800	1825	2	636938	*
2 x CC 670	1365	3	637017	*
2 x CC 900	1825	3	636913	*
CC 900 + 670	1595	3	636825	*

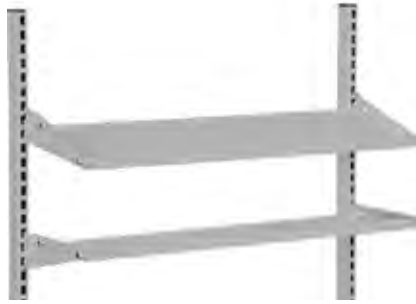

Storage shelves

Shelves with suspension brackets for correct placement in columns on work desks or on assembly trailers. The shelves have curved edges on all four sides and have a capacity of 50 kg distributed load. As an option, an additional grooved rubber mat is ordered for less noise and non-slip storage on the shelf. Colour: Grey RAL7004.

W x D (mm)	Suitable for shelves (mm)	Capacity (kg)	SKU	Price
645 x 450	670	50	634454	*
645 x 210			634455	*
875 x 613	900	100	634464	*
875 x 210		50	634453	*



ESD shelves

ESD shelves including brackets, for mounting on perforated columns. The shelf surface is grey high-pressure laminate and the edge strip is solid beech. On the underside of the shelf is an ESD earthing terminal.

Colour	Light Grey		
Surface	HPL		
Border	Solid beech		
Size (mm)	Thickness (mm)	SKU	Price
670 x 300	24	638225	*
900 x 300	24	638226	*
1340 x 300	24	638227	*
1800 x 300	24	638228	*



ESD shelf mat

Shelf mat with 2 pcs. 10 mm push-button for necessary connection.

Colour	Size (mm)	Custom CC (mm)	SKU	Price
Grey	640 x 295	670	396490	*
	865 x 295	900	396491	*

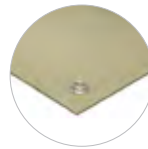

ESD table mats

ESD table mats for placement on a work table. The mat has 3 push buttons with a diameter of Ø10 mm for earth connection.

Colour	1200x800		1500x800		2000x800	
	SKU	Price	SKU	Price	SKU	Price
Beige	636571	*	636574	*	636577	*
Blue	636572	*	636575	*	636578	*
Grey	636573	*	636576	*	636579	*



ESD Table Top 24mm

24mm thick tabletops for use in ESD environments. The top of the tabletop is grey high pressure laminate (HPL) or grey linoleum (U12188MP), the underside has a barrier layer and the top is edged with solid wood, beech edging. Under the table top is mounted ESD grounding terminal, GBP grounding connection on the right front of the table top. HPL provides a hard scratch resistant tabletop with high resistance to liquids and chemicals. Option with linoleum surface provides a table top with slightly softer expression and high impact resistance. These table tops fit all our workshop table bases, with the exception of the heavy trestles.

Colour	Light Grey
Border	Solid beech

		SKU	Price
HPL	1200 x 800	625592	*
	1500 x 800	625597	*
	2000 x 800	625598	*
Linoleum	800 x 620	628063	*
	1200 x 620	626113	*
	1500 x 620	626114	*
	2000 x 620	626115	*
	1200 x 800	625591	*
Linoleum	1500 x 800	625593	*
	1600 x 800	628064	*
	2000 x 800	625595	*





ESD Grounding terminals

Small and convenient terminals for easy access under the tabletop. Terminals are supplied including 3.0m connection cable with ring terminals.

	SKU	Price
3 x banana squeeze	396496	*

ESD grounding cables

Earthing cables in different lengths, for connecting ESD elements such as shelf mats, table mats, suspension strips, etc.



	Length (metres)	SKU	Price
Black	0,15	615500	*
Black	2	615501	*



ESD wristband

Practical ESD wristbands and coiled cables, for proper protection of your ESD workplace.

Beskrivelse	Colour	Connection	Length and distance	SKU	Price
Wristbands	metal	7 mm		636597	*
Wristbands	metal	10 mm		636596	*
Wristbands	Red	10 mm		636598	*
spiral cable	Black	7/10 mm button	1.8 m	396504	*
spiral cable	Black	10 mm button/track	1.8 m	636626	*
spiral cable	Black	10 mm button/knob	1.8 m	636627	*

Wave LED MAGNIFIER

Wave LED is a magnifying lamp adapted to industrial environments. Supplied with 2 x 400 lm LED light source and a flexible self-balancing arm. It offers shadow-free magnification with light from both sides. Wave ESD with UV light is a magnifying lamp ideal for inspecting conformal coatings as well as welds, solder joints and other areas of stress concentrations.



	Colour	Magnification Primary Lens	Enlargement (%)	Brightness (lumen)	SKU	Price
LED ESD	Black	3.5 diopter	187.5	59	302027	*
LED ESD		5.0 diopter	225		302028	*
UV ESD	Alugrey	3.5 diopter	187.5		302029	*

ESD floor mat ErgoDurk

ErgoDurk are durable two-layer workplace mats that provide excellent comfort. The surface has a modern industrial design that makes it non-slip and satisfies the day HSE requirements. The underside of the Nitricell is resilient and elastic, relieving pressure on the feet, legs and back throughout the working day. The floor mat is ESD approved with the possibility of connection to ground. Colour: Black. Thickness (mm) 11.

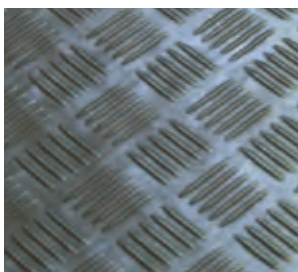

	Unit	SKU	Price
2000 x 700	Pcs	302064	*
1400 x 1000	Pcs	302063	*
700 x 10000	Pcs roll	302061	*
1000 x 10000	Pcs roll	302065	*

adhesive mat

The sticky mat captures dirt and dust from shoes, tyres, etc. Placed, for example, at the entrance to cleanrooms, ESD rooms or other controlled environments. The mats are easily attached to the floor or to a frame with double-sided tape. A transparent protective layer protects the top part of the adhesive mat until it is ready for use. The corner tabs are numbered to show the number of sheets remaining and help prevent multiple sheets from being removed at the same time.



No. of sheets per pack	30 pcs		
Colour	White		
	Dimensions (mm)	SKU	Price
Frame incl. 30 adhesive pads	610 x 1290	639332	*
Adhesive mat 10-pack	460 x 1140	639333	*
Adhesive mat 50-pack	460 x 1140	640379	*

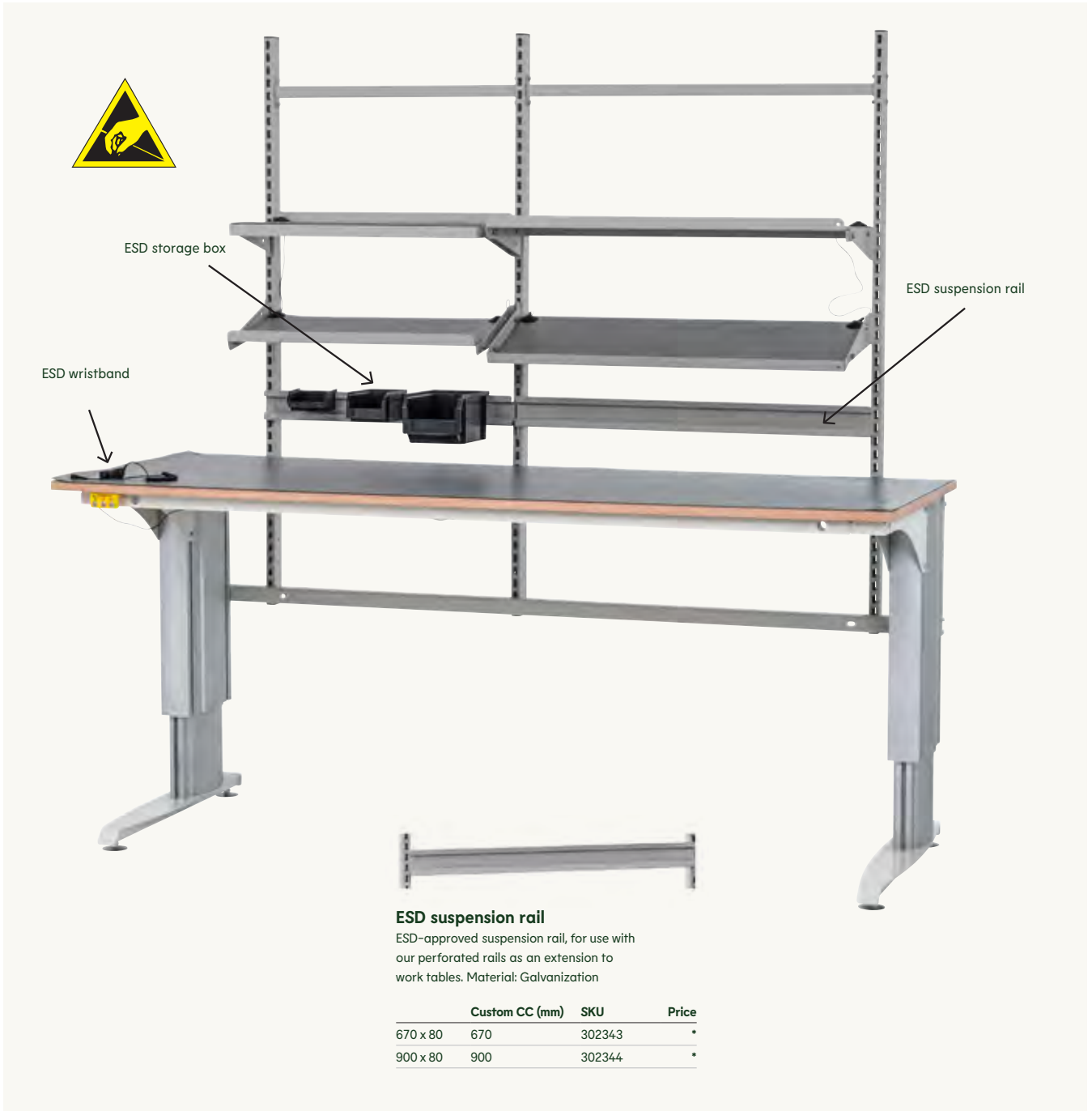

ESD suspension rail

ESD-approved suspension rail, for use with our perforated rails as an extension to work tables. Material: Galvanization

	Custom CC (mm)	SKU	Price
670 x 80	670	302343	*
900 x 80	900	302344	*



ESD storage box - Black

Conductive storage boxes in ESD design.

Size dxwxh (mm)	SKU	Price
400x160x100	636609	*
500x160x100	636610	*
650x160x100	636611	*



ESD picking boxes - Black

Stackable and conductive picking boxes in ESD design.

Size dxwxh (mm)	SKU	Price
350x210x145	636617	*
350x210x200	636618	*
500x310x145	636619	*
500x310x200	636620	*
500x310x300	636621	*



ESD EUR box

Stackable EUR box in ESD design, designed for transport and storage of ESD-sensitive parts. Colour: Black. Capacity (kg): 500.

	Size dxwxh (mm)	SKU	Price
4308	400x300x75	636585	*
4312	400x300x120	636586	*
4317	400x300x170	636587	*
4322	400x300x220	636588	*
6408	600x400x75	636589	*
6412	600x400x120	636590	*
6417	600x400x170	636591	*
6422	600x400x220	636592	*



ESD industrial chair Comfort

Anti-static chair, perfect for anyone working with sensitive electronics. Seat and backrest in conductive polyurethane and with easy-rolling ESD wheels. The chair features easy stepless adjustment of both seat and backrest using the globally designed seat mechanism. Back support: 16° forwards and 6° backwards, seat: 12° forwards and 3° backwards. Polyurethane foam provides good seating comfort and is practical and robust – even in demanding environments. Polyurethane is resistant to many types of liquids and chemicals and is also easy to keep clean.

Back size W x H (mm)	370 x 310
Seat size W x D (mm)	420 x 420
Seat height (mm)	500 - 630
Foot cross diameter Ø (mm)	610
Foot crosses	Chrome

	Foot Ring	SKU	Price
Low	No	608033	*
High	Yes	608034	*

ESD industrial chair 5002

5002 ESD work chair can be raised and lowered, has an adjustable backrest that can also be adjusted in depth and an angle-adjustable seat. The 5000 series is popular in both laboratory and industrial environments. 5002 is equipped with a medium-high back. The chair is covered with Gaja antistatic fabric in grey. Footstool in aluminium with antistatic castors. Seat height 448-586 mm



textile	Gaja antistatic grey	
Foot crosses	Aluminum	
Execution	ESD	
Seat height	SKU	Price
448-556 mm	636663	*

ESD industrial chair 8000

The 8000 ESD task chair has many unique adjustment options. The chair can be raised and lowered, has an adjustable backrest that can also be adjusted in depth, and a tilttable seat. The chair is equipped with a tilt function, adjustable armrests and a leatherette headrest. The chair is upholstered in Gaja antistatic fabric in grey and has a protected seat for extra durability. Base in black aluminium with anti-static castors. Seat height 449-587 mm.



Textile	Gaja antistatic grey	
Foot crosses	Aluminium, black	
Execution	ESD	
Seating height	SKU	Price
449-587	640388	*



416923

415839

415841

415840

415842

ESD shelf trolley

ESD trolley for EPA environments EPA (ESD-Protected-Area). The trolleys are designed to safely dissipate static electricity. They are approved by RISE Research Institutes of Sweden with SP method 2472 and fulfil the requirements of IEC 61340-5-1 and N 100015-1. Shelf panels 19 mm with conductive melamine on both sides. Black ABS edging on all four sides. Shelves and drive handles are infinitely adjustable for easy customisation as needed. Colour: Galvanization.

L x D x H (mm)	No. of shelves (pcs)	Max load trolley (kg)	SKU	Price
900 x 460 x 890	2	150	416923	*
800 x 460 x 1120	2	200	415839	*
800 x 460 x 1120	3	200	415841	*
930 x 460 x 1120	2	200	415840	*
1380 x 460 x 1120	3	200	415842	*

ESD Table trolley

The trolleys are designed to safely dissipate static electricity. They are approved by RISE Research Institutes of Sweden with SP method 2472 and fulfil the requirements of IEC 61340-5-1 and N 100015-1. Shelf panels 19 mm with conductive melamine on both sides. Black ABS edging on all four sides. Shelves and drive handles are infinitely adjustable for easy customisation as needed.



No. of shelves (pcs)	2			
Colour	Galvanization			
L x D x H (mm)	Shelf dim. (mm)	Max load trolley (kg)	SKU	Price
405 x 385 x 1100	600 x 430	50	415843	*
750 x 430 x 900	820 x 620	100	415844	*
1130 x 430 x 900	1200 x 600	100	199994	*

ASD work table Red

ESD-adapted work and assembly table, with 5 ESD castors, 2 of which are lockable, easy adjustment with gas cartridge for stepless height adjustment between 620 - 875 mm. Tilttable table top 0-40 degrees. Table top 500x350 mm with bevelled edge, powder-coated: RAL3000.

Foot cross Ø (mm)	560	
Height adjustment (mm)	580 - 940	
Lifting capacity (kg)	25	
Max load (kg)	100	
Wheels ESD (pcs)	5	
Wheels ESD with brake (pcs)	2	
Tabletop colour	Red RAL3000	
Colour undercarriage	Black	
	SKU	Price
500 x 300	608032	*



*) Contact Sono for prices

Complete packing tables

With three alternative table models and a wide range of accessories, you can easily assemble your complete packing table tailored to your needs. In addition, we have put together a number of ready-made packaging solutions for small and large packaging needs. See subsequent pages in the directory.

- Build your own packing station
- Flexible
- Wide range of items



GBP

The pictured packing table contains: 1. Heavy trestles with wheel suspension. 2. 40 mm table top with grey vinyl 2000x800 mm. 3. Attachment frame for heavy leg trestles, width 2000 mm.

4. Perforated columns, height 1926 mm. 5.1 Shaft for perforated columns, CC 1800 mm. 5.2. Shaft with bracket for columns, CC 1800 mm. 5.3. Shaft for heavy leg braces, width 2000 mm. 6. Cutting unit with cutting width 1500 mm. 7. Electrical panel, CC 1800 mm. 8. Storage shelf 1800 x 300 mm and shelf dividers, height 200 mm. 9. Fixed arm with balance block. 10. Articulating arm with flat panel and keyboard holder. 11. LED light, CC 1800 mm. 12. Wheelset.

HPL 

Packing table combination 1 - Light work table

Complete packing table on H stand with 24mm grey HPL tabletop. Included in the combination is a cutting knife, 1 shelf with 6 dividers and 2 axles for packing materials, of which 1 axle is in the body and 1 axle is under the table.

Working height excl. table top (mm)	700 - 950
Load (kg)	150
Tabletop color	Light Grey
Table top surface	High pressure laminate
Table top thickness (mm)	24
Border colour	Mocha grey
Undercarriage Color	Grey RAL7004

	SKU	Price
1500 x 800	636721	*
2000 x 800	636727	*

HPL 

Packing table combination 3 - Workshop bench

Complete heavy-duty leg rack with 40mm grey HPL tabletop and lower shelf, 2 shelves with 10 dividers and 1 articulated arm with flat panel and keyboard holder.

Working height excl. table top (mm)	700 - 970
Load (kg)	750
Tabletop color	Light Grey
Table top surface	High pressure laminate
Table top thickness (mm)	40
Border colour	Mocha grey
Undercarriage Color	Grey RAL7004

	SKU	Price
1500 x 800	636944	*
2000 x 800	636948	*

HPL 

Packing table combination 5 - Light work table

Complete packing table on H stand with 24mm grey HPL tabletop. Included in the combination is a cutting knife, 2 shelves, 6 dividers and 2 axles for packing materials, of which 1 axle is in the body and 1 axle is under the table.

Working height excl. table top (mm)	700 - 950
Load (kg)	150
Tabletop color	Light Grey
Table top surface	High pressure laminate
Table top thickness (mm)	24
Border colour	Mocha grey
Undercarriage Color	Grey RAL7004

	SKU	Price
1500 x 800	636804	*
2000 x 800	636728	*



HPL

Packing table combination 6 - Light work table

Complete workbench on H-stand with 24mm grey HPL tabletop, 2 shelves and 6 dividers. The HPL surface provides a table top with high scratch resistance and is resistant to liquids and chemicals. Capacity is 150 kg distributed load.

Working height excl. table top (mm)	700 - 950
Load (kg)	150
Tabletop color	Light Grey
Table top surface	High pressure laminate
Table top thickness (mm)	24
Border colour	Mocha grey
Undercarriage Color	Grey RAL7004
	SKU
	Price
1500 x 800	636722 *
2000 x 800	636697 *



HPL

Packing table combination 7 - Workshop bench

Complete package table on heavy leg stands with 40 mm grey HPL tabletop. Included in the combination is a cutting knife, 2 shelves with 6 dividers and 2 axles for packing materials, of which 1 axle is in the body and 1 axle is under the table.

Working height excl. table top (mm)	700 - 970
Load (kg)	750
Tabletop color	Light Grey
Table top surface	High pressure laminate
Table top thickness (mm)	40
Border colour	Mocha grey
Undercarriage Color	Grey RAL7004
	SKU
	Price
1500 x 800	636687 *
2000 x 800	636884 *



HPL

Packing table combination 8 - Workshop bench

Complete package table on heavy leg stands with 40 mm grey HPL tabletop. Included in the combination are 2 shelves with 6 dividers. The HPL surface provides a table top with high scratch resistance and is resistant to liquids and chemicals. Capacity is 750 kg distributed load.

Working height excl. table top (mm)	700 - 970
Load (kg)	750
Tabletop color	Light Grey
Table top surface	High pressure laminate
Table top thickness (mm)	40
Border colour	Mocha grey
Undercarriage Color	Grey RAL7004
	SKU
	Price
1500 x 800	636834 *
2000 x 800	636766 *



HPL

Packing table combination 9 - ErgoMini

Complete packing table with electric lift-lower base ErgoMini and 24 mm grey HPL table top. Included in the combination is a cutting knife, 2 shelves with 6 dividers and 2 axles for packing materials in the bodywork, of which 1 axle is on the console for placement at the rear edge of the table.

Working height excl. table top (mm)	710 - 1160
Load (kg)	180
Lifting speed (mm/sec)	20
Tabletop color	Light Grey
Table top surface	High pressure laminate
Table top thickness (mm)	24
Border colour	Dark Grey
	SKU
	Price
1500 x 800	636828 *
2000 x 800	636961 *



HPL

Packing table combination 10 - ErgoMini

Complete packing table with electric lift-lower base ErgoMini, with 24 mm grey HPL table top, 2 shelves and 6 dividers.

Working height excl. table top (mm)	710 - 1160
Load (kg)	180
Lifting speed (mm/sec)	20
Tabletop color	Light Grey
Table top surface	High pressure laminate
Table top thickness (mm)	24
Border colour	Dark Grey
	SKU Price
1500 x 800	636962 *
2000 x 800	636779 *



HPL

Packing table combination 11 - Table 400

Complete Packing Table with Electric Raise-Lower Chassis Table 400 and 24mm Grey HPL Table Top. Included in the combination are: perforated columns, attachment frame, mounting kit, 2 shelves and 6 dividers.

Working height excl. table top (mm)	685 - 1085
Load (kg)	400
Lifting speed (mm/sec)	13
Tabletop color	Light Grey
Table top surface	High pressure laminate
Table top thickness (mm)	24
Border colour	Dark Grey
	SKU Price
1500 x 800	636837 *
2000 x 800	636767 *



HPL

Packing table combination 12 - Table 400

Complete Packing Table with Electric Raise-Lower Chassis Table 400 and 24mm Grey HPL Table Top. Included in the combination are: perforated columns, attachment frame, mounting kit, 2 shelves, 10 dividers and 1 articulated arm with keyboard holder and monitor mount.

Working height excl. table top (mm)	685 - 1085
Load (kg)	400
Lifting speed (mm/sec)	13
Tabletop color	Light Grey
Table top surface	High pressure laminate
Table top thickness (mm)	24
Border colour	Dark Grey
	SKU Price
1500 x 800	636765 *
2000 x 800	636700 *



HPL

Packing table combination 13 - Table 400

Complete Packing Table with Electric Raise-Lower Chassis Table 400 and 24mm Grey HPL Table Top. Included in the combination are: perforated columns, attachment frame, mounting kit, 1 shelf, 6 dividing plates, 1 cutting knife and 1 axle for packing material.

Working height excl. table top (mm)	685 - 1085
Load (kg)	400
Lifting speed (mm/sec)	13
Tabletop color	Light Grey
Table top surface	High pressure laminate
Table top thickness (mm)	24
Border colour	Dark Grey
	SKU Price
1500 x 800	636744 *
2000 x 800	636812 *



HPL 

Packing table combination 14 - Table 400

Complete Packing Table with Electric Raise-Lower Chassis Table 400 and 24mm Grey HPL Table Top. Included in the combination are: perforated columns, attachment frame, mounting kit, 2 shelves, 10 dividers, 1 binder holder and 1 articulated arm with keyboard holder and monitor mount.

Working height excl. table top (mm)	685 - 1085
Load (kg)	400
Lifting speed (mm/sec)	13
Tabletop color	Light Grey
Table top surface	High pressure laminate
Table top thickness (mm)	24
Border colour	Dark Grey
	SKU
	Price
1500 x 800	636947 *
2000 x 800	636746 *



Additional handle
SKU 636324. Price *

Package trolley Flex

As a starting point for building a flexible rolling frame, we have put together a base frame for building the desired equipment. The stand has Ø125 mm swivel castors, of which 2 are lockable. The height of the perforated columns is 1446 mm. Handles as depicted are ordered separately.

H x W x D (mm)	SKU	Price
1655 x 1375 x 610	636784	*
1655 x 1800 x 610	636935	*



Packing trolley - combination 1

Complete combination based on the Flex trolley, with a width of 1350 mm. The combination includes, in addition to the trolley itself, cutting unit with cutting width 1000 mm, 1 axle for packing material and 300 mm deep shelf with 6 partitions. The height of the perforated columns is 1446 mm.

H x W x D (mm)	1655 x 1375 x 610
Cutting Width (mm)	1000
Shelf Width (mm)	1315
Load (kg)	120
SKU	Price
636853	*



Packing trolley - combination 2

Complete combination based on the roller trolley Flex, with width 1350 mm, including cutting unit with cutting width 1000 mm and 1 axle for packing material. The height of the perforated columns is 1446 mm.

H x W x D (mm)	1655 x 1375 x 610
Cutting Width (mm)	1000
Shelf Width (mm)	1315
Load (kg)	120
SKU	Price
636971	*



Packing trolley - combination 3

Complete combination based on the Flex trolley, with a width of 1350 mm. In addition to the trolley itself, the combination contains 4 shelves with a depth of 300 mm, 10 dividers with a height of 200 mm and 2 dividers with a height of 400 mm. The height of the perforated columns is 1446 mm.

H x W x D (mm)	1655 x 1375 x 610
Load (kg)	120
SKU	Price
636788	*



Attachment set packing table

Complete attachment kit for packing table with columns 1926 mm. The combination includes: perforated columns, mounting kit, cutting knife, 2 shelves, 6 dividers and 2 axes for packing materials, of which 1 axle is on the bracket for placement at the rear of the table.

Length perf columns (mm)	1926
Qty	2

Total width (mm)	CC dim. (mm)	SKU	Price
1365	1340	636928	•
1825	1800	636715	•

GBP

Wrapping Table Attachment Kit



Attachment set packing table

Complete attachment kit for packing table with columns 1926 mm. The combination includes: perforated columns, mounting kit, cutting knife, 2 shelves and 6 dividers.

Length perf columns (mm)	1926
Qty	2

Total width (mm)	CC dim. (mm)	SKU	Price
1365	1340	636921	•
1825	1800	636716	•



Attachment set packing table

Complete attachment kit for packing table with columns 1926 mm. The combination includes: perforated columns, mounting kits, 2 shelves and 6 dividers.

Length perf columns (mm)	1926
Qty	2

Total width (mm)	CC dim. (mm)	SKU	Price
1365	1340	636920	•
1825	1800	636929	•

*) Contact Sono for prices

Workbench attachment kit

To make your choices easier when it comes to bodywork for our work tables, we have put together different options - for different applications. They are sold complete, but you must supplement with a table attachment frame where one is not included.

- Build the workplace to your needs

GBP

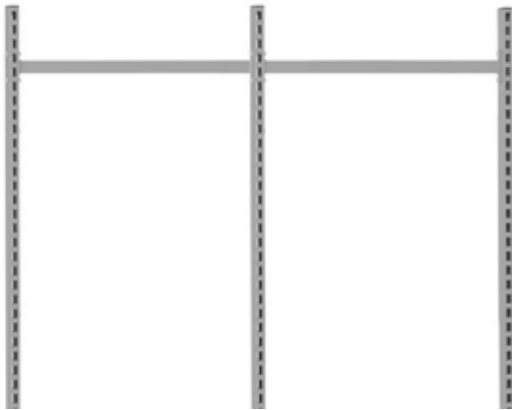

Attachment Kit BASIC

BASIC attachment kit for work tables and packing tables with perforated columns 1446 mm, spacers and mounting kit. Fits Light H, Workshop Bench, ErgoMini, ErgoNomi and Table 400.

	Total width (mm)	SKU	Price
CC 670	695	636866	*
CC 900	925	636846	*
CC 1375	1365	637041	*
CC 1800	1825	636937	*
2 x CC 670	1365	636793	*
2 x CC 900	1825	636823	*
CC 900 + 670	1595	636711	*
CC 1800 + 670	2035	637016	*
CC 1375 + 900	2265	636954	*
3 x CC 370	2035	636933	*
2 x CC 670 + CC 900	2265	636824	*

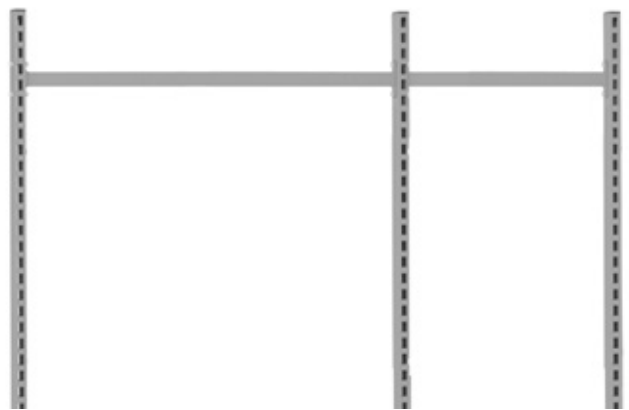

Basic add-on kit for ErgoMulti

Basic extension kit for worktables and packing tables with perforated columns 1446 mm, centre brace and mounting kit. Fits ErgoMulti.

	Total width (mm)	Qty	SKU	Price
CC 670	695	2	636867	*
CC 900	925	2	636955	*
CC 1375	1365	2	637032	*
CC 1800	1825	2	636938	*
2 x CC 670	1365	3	637017	*
2 x CC 900	1825	3	636913	*
CC 900 + 670	1595	3	636825	*



Attachment set work table - combination C

Complete attachment kit for work table with columns 1926 mm. The attachment kit includes: perforated columns, mounting kit, 1 tool board, 2 shelves, 2 suspension strips, 2 spacers and LED lighting. Hooks and plastic boxes are sold separately.

	Total width (mm)	Qty	SKU	Price
2 x CC 670 comb. C	1365	3	636782	*
2 x CC 900 comb. C	1825	3	636752	*



Attachment kit work table CC 670

Complete attachment kit for work table CC 670 mm with columns 1926 mm. The attachment kit includes: perforated columns, mounting kit, 1 shelf, 1 spacer bar and 1 plastic box suspension strip. Complete the suspension molding with plastic boxes for smart and convenient storage.

	Total width (mm)	Qty	SKU	Price
CC 670	695	2	636792	*



Attachment kit work table CC 900

Complete attachment kit for work table CC 900 mm with columns 1926 mm. The attachment kit includes: perforated columns, mounting kit, 1 tool board and 1 shelf. Complete your toolboard with our wide selection of hooks.

	Total width (mm)	Qty	SKU	Price
CC 900	925	2	636789	*



Attachment set worktable - combination A

Complete attachment kit for work table with columns 1926 mm. The attachment kit includes: perforated columns, mounting kit, 1 tool board, 2 shelves and 1 suspension strip. Complete the toolboard with our wide range of hooks and the suspension molding with plastic boxes.

	Total width (mm)	Qty	SKU	Price
2 x CC 670 comb. A	1365	3	637015	*
2 x CC 900 comb. A	1825	3	636964	*



Attachment set worktable - combination B

Complete attachment kit for work table with columns 1926 mm. The attachment kit includes: perforated columns, mounting kit, 2 tool boards, 1 shelf and 1 suspension strip. Complete the toolboard with our wide range of hooks and the suspension molding with plastic boxes.

	Total width (mm)	Qty	SKU	Price
2 x CC 670 comb. B	1365	3	637014	*
2 x CC 900 comb. B	1825	3	636963	*

*) Contact Sono for prices

Work & Packing Table Accessories

All our work tables can be supplemented with accessories and extensions. For individual adaptation of the workplace, we offer a wide range of shelves, tool panels, cabinets, arms and other accessories.

- The superstructure is the starting point for an adapted workplace



Perforated Columns

Perforated columns for fixing at the back of packing and work tables, for use with our rich range of accessories. The columns consist of profiles of 25x50 mm. The net height above the table top is approximately 400 mm less than the column height (depending on the thickness of the table top). Mounting kit must be ordered in addition, 1 kit per column.



	SKU	Price
Column 1-pack, height 1446 mm	634475	*
Column 1-pack, height 1926 mm	634480	*
Bracket for attaching column to 40 mm table top	636228	*
Attachment Frame Column Mounting Kit	301464	*
Pillar Safety Stops	436073	*

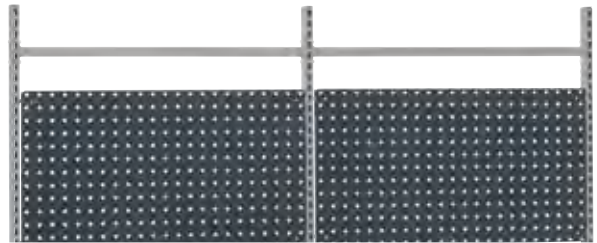

	Length (mm)	SKU	Price
Intermediate strut CC670 mm	645	634482	*
Intermediate strut CC900 mm	875	634483	*
Intermediate strut CC1340 mm	1315	636290	*
Intermediate strut CC1800 mm	1775	636307	*



Tool Panel

Perforated tool board with 9 mm square hole with cc dimensions 38 mm. With the included mounting kit, the boards are easily mounted in columns on work tables, on wall rails or on mounting trolleys. The boards can also be mounted directly on the wall.

W x H (mm)	CC dimensions (mm)	SKU	Price
640 x 480	670	634485	*
870 x 480	900	634486	*



Perforated tool cabinet D120

Lockable tool cabinet for use with perforated columns on work tables or assembly trailers. With both doors open, the cabinet expands into a practical tool board with a full 2 m width. The cabinet is perforated with 9 mm square holes with cc dimensions 38 mm.

W x D x H (mm)	Lock Type	SKU	Price
870 x 120 x 475	Key lock	636295	*



Perforated tool cabinet D250

Lockable tool cabinet for use with perforated columns on work tables or assembly trailers, alternatively the cabinet can be hung directly on the wall. The cabinet is perforated with 9 mm square holes with 38 mm cc dimensions and mounting brackets for columns included. Lock Type: Cylinder lock

W x D x H (mm)	SKU	Price
870 x 250 x 715	636312	*
Extra shelf	636235	*



Magnetic whiteboard

Boards used as whiteboards and/or magnetic boards for use with perforated columns on work tables or assembly carts, alternatively the boards can be hung directly on the wall

H x W (mm)	SKU	Price
480 x 640	301476	*



Suspension rail

Suspension rail for plastic storage boxes, comes with integrated brackets for straight or angled mounting, in columns on work tables, on wall rails or on mounting trolleys. Capacity is 20 kg distributed weight.

CC dim. (mm)	SKU	Price
670	634472	*
900	634473	*
2 x 670	636219	*
2 x 900	636269	*



Suspension rail, perforated

Perforated tool strip with 9 mm square hole with CC dimensions 38 mm. With the included mounting kit, the strip is easily mounted in columns on work tables, on wall rails or on mounting carts.

H x W (mm)	SKU	Price
70 x 670	636229	*
70 x 900	636230	*
70 x 1340	636267	*
70 x 1800	636277	*

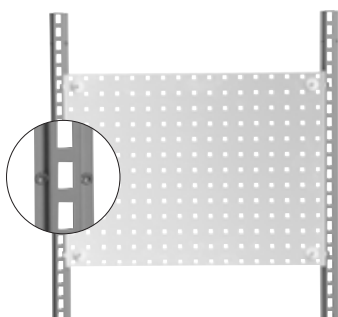

Perforated wall rails

Perforated columns for mounting directly on the wall. The wall rails are priced and supplied in pairs, wall-mounted with mounting kit (included).

Length (mm)	SKU	Price
1000	634457	*



Storage shelves

Shelves with suspension brackets for straight or inclined placement in columns on work tables, on wall rails or on assembly trolleys. The shelves can be placed with a wobble edge at the front or rear and have a capacity of 50 kg distributed load.

W x D (mm)	SKU	Price
645 x 300	634470	*
875 x 300	634478	*
875 x 457	634469	*

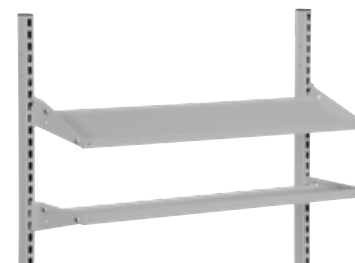

Storage shelves

Shelves with suspension brackets for correct placement in columns on work desks or on assembly trailers. The shelves have curved edges on all four sides and have a capacity of 50 kg distributed load. As an option, an additional grooved rubber mat is ordered for less noise and non-slip storage on the shelf.

W x D (mm)	SKU	Price
645 x 210	634455	*
645 x 450	634454	*
875 x 210	634453	*
875 x 613	634464	*



Shelf dividers

Shelf divider for use as a binder support, side support or other type of shelf divider. The dividers are supplied in 2-pack, are adapted to shelves with a depth of 300 mm and are supplied in 2 heights.

H x D (mm)	SKU	Price
200 x 300	636344	*

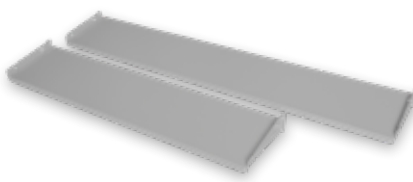

Storage shelves

Shelves with suspension brackets for correct placement in pillars on packing and work tables or on assembly and packing trolleys. The shelves have a capacity of 35 kg distributed load.

W x D (mm)	SKU	Price
1350 x 300	636331	*
1800 x 300	635177	*



Packing Table Shelf

The shelf is smooth without edges and comes with 2 brackets for mounting on perforated columns, on work and packing tables, flex trolleys, floor standing L and T racks or on our assembly trolleys.

W x D (mm)	CC dimensions (mm)		SKU	Price
1315 x 457	1340		636214	*
1775 x 457	1800		636217	*

*) Contact Sono for prices

Work & Packing Table Accessories

Complete your work or packing table with a range of products - for a simpler everyday life.



Double arm articulation

Weight (kg)	02.feb.
Max. load distributed (kg)	15
SKU	637029
Price	*



Pickbox shelf

H x W x D (mm)	120 x 545 x 170
Weight (kg)	5
Max. load (kg)	15
SKU	636790
Price	*



Double Pick Box List

H x W x D (mm)	125 x 450 x 50
Weight (kg)	04.mai
Max. load (kg)	15
SKU	636794
Price	*



Document holder

H x W (mm)	330 x 290
Weight (kg)	03.mai
Max. load (kg)	15
SKU	636934
Price	*



Monitor Holder

Weight (kg)	3
Max. load distributed (kg)	15
SKU	637013
Price	*



Tilting shelf

H x W (mm)	305 x 405
Weight (kg)	5
Max. load (kg)	15
SKU	636279
Price	*



Monitor & Keyboard Holder

Weight (kg)	5
Max. load distributed (kg)	15
SKU	636996
Price	*



Pull-out keyboard shelf 20 kg

Weight (kg)	3,6
Max. load distributed (kg)	20
SKU	636337
Price	*



Perm holder for column

H x W x D (mm)	320 x 145 x 250
Weight (kg)	2,3
SKU	637030
Price	*



Footrest, freestanding with rubber mat

H x W x D (mm)	350 x 500 x 350
Weight (kg)	9
SKU	636965
Price	*

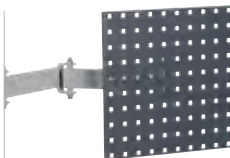

Tool panel for superstructures

H x W (mm)	370 x 370
Weight (kg)	3,5
Max. load (kg)	15
SKU	636783
Price	*



Articulated arm with keyboard holder

SKU 636997 . Price *



Retractable Printer Shelf

SKU 636268 . Price *



Scanner/Tape Dispenser Shelf

SKU 636241 . Price *



Perforated column cable duct

SKU 636223 . Price *



PC holder with straps and pillar mount

SKU 635866 . Price *



Coupling bracket for Light H chassis

SKU 636227 . Price *

Table Scales

High-precision platform scales for tabletop placement or tabletop folding. Then select the frame to be folded down.

	SKU	Price
Weight 6000 KD 150 kg	436105	*
Table Scale Folding Frame KD6000	436099	*
Weight FW66 60 kg	436136	*
Table weight folding frame FW66/KW66	435528	*
Weight PV490 150kg	435539	*

436136

435539



435528

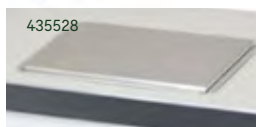

436105

436099

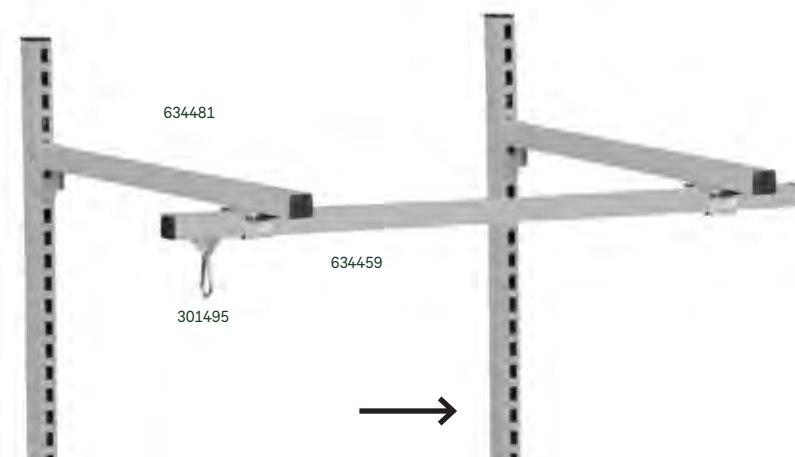
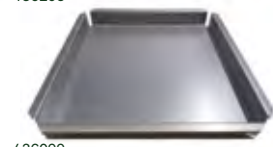

C-profile rail for suspension

Concept for suspension of movable tool suspension and lighting. The fixed arm is mounted in a perforated column on packing and work tables, on wall rails or trolleys and has a length of 700 mm. Depending on the desired width, select the c-profile rail that is mounted with its own mounting brackets (1 pc included in fixed arm). Then choose from our good selection of lighting solutions and equipment for hanging tools.



301495



301498



301497



301496

	SKU	Price
Balance block 0.6-1.5 kg	301499	*
Balance block 1.0-2.0 kg	301500	*
Balance block 1.5-3.0 kg	301934	*
C-profile rail 1200 mm	634459	*
C-profile rail 1490 mm	634466	*
C-profile rail 1990 mm	634458	*

	SKU	Price
C-Profile End Stop	301497	*
Fixed arm for c-profile rail	634481	*
Mounting bracket for c-profile	301498	*
Tool Trolley	301495	*
Suspension eye 2-pack	301496	*
Swivel arm with eye hook	636275	*

*) Contact Sono for prices

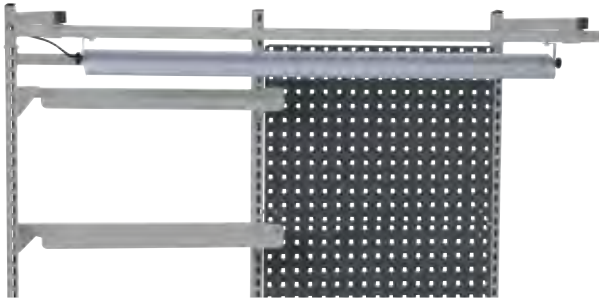

LED Light Fixture - Kit

Set of sturdy LED work lights with dimming, two arms and C-profile. The lamps are made of aluminum and can be angled.

	SKU	Price
Length 1500 mm	637031	*
Length 2000 mm	636780	*



Bar Go led list

An energy-efficient led strip that comes prepared with magnetic mount and alternative screw mounting. It is only 10 x 10 mm (w x h), which is a great option for installation in small rooms. The 12V cable is 1 meter long. The LED strip is particularly suitable for placement on the underside of shelves or on perforated columns. Including transformer 220W / 12V and magnetic mount. 1.8 m DC cable, dimming switch.

Volt	12VDS
Wattage (W)	11,5
Lumen (lm)	1093
Lumen/Watt (lm/W)	95,04
IP-class	IP43
Dimensions L x D x H (mm)	1150 x 10 x 10
Weight kg	0,15
SKU	436204
Price	*



LED lamp fitting

Solid work light with dimming for optimal work light. The lamps are made of aluminum and can be angled. Comes complete with mounting brackets and 3 m cord and is intended for mounting in fixed arm for side mounting or in c-profile rail.

Installation	Length (mm)	Brightness (lumen)	Power (w)	SKU	Price
Right	600	2200	19	302023	*
Left	600	2200	19	302022	*
Transversal	1200	4400	38	302020	*
Transversal	1800	4400	57	302021	*



Led-lighting

A compact longitudinal illumination with LED bulbs. The brackets are bolted with popnuts for stable suspension. The led units can be moved sideways if you want a variable slide.

Width (mm)	Colour	SKU	Price
670	RAL 9006	301504	*
900		301505	*
1340		301506	*
1800		301507	*



Vertical power rail

The energy panel is mounted vertically in one of our columns. The panel has 4 sockets with power switch that illuminates when the power is on. 2 m cable included.

SKU	Price
302024	*



Panel

Approved power panel with power switch, for mounting between perforated columns. The panel has 6 earthed connectors, illuminated circuit breaker, 2m cable with earthed plug and mounting brackets for mounting in columns. Connects 230V - 50Hz.

	Width (mm)	Weight (kg)	SKU	Price
670 mm	670	01.mai	301508	*
900 mm	900	2	301509	*
1350 mm	1375	02.jul	301510	*
1775 mm	1800	03.mai	301511	*

Wave LED MAGNIFIER

Wave LED is a magnifying lamp adapted to industrial environments. Supplied with 2 x 400 lm LED light source and a flexible self-balancing arm. It offers shadow-free magnification with light from both sides. Wave ESD with UV light is a magnifying lamp ideal for inspecting conformal coatings as well as welds, solder joints and other areas of stress concentrations.



	Colour	Magnification Primary Lens	Enlargement (%)	Brightness (lumen)	SKU	Price
LED	White	3.5 diopter	187.5	59	302025	*
		5.0 diopter	225		302026	*
LED ESD	Black	3.5 diopter	187.5	59	302027	*
		5.0 diopter	225		302028	*
UV ESD	Alugrey	3.5 diopter	187.5		302029	*



301525



301532



301530

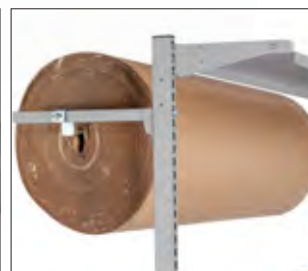

301527

Axles for packing table

Complete shafts for use with packing tables. Select placement in table jackets or between vertical columns. With the axle option on the console, you can place rolls for kraft paper, corrugated board, etc. at the rear of the table, freeing up work space.

	Width (mm)	SKU	Price
For H-stand chassis	1420	301525	*
	1920	301526	*
With column console	1375	301527	*
	1800	301528	*
For perforated columns	1375	301529	*
	1800	301530	*
For heavy leg trestles	1215	301531	*
	1715	301532	*

Cutting unit

Highly flexible aggregate for cutting corrugated board, kraft paper, bubble wrap, foam, etc. The rig is placed on a packing table or in combination with the corresponding console for use on the Flex trolley. Extremely sturdy cutting blade in hardened steel.

	SKU	Price
Width 1360 mm	301521	*
Width 1860 mm	301520	*
Console Flex Cart	636338	*

BS1/VS1 Desk Drawer Sections

GBP drawer sections for worktable and freestanding placement. Lockable drawer sections that are mounted in the table stand using suspension profiles, or screwed directly into a 40 mm table top. The desk drawer section is available in three heights and the free-standing drawer section in five heights. Hull RAL 9002, buckets RAL 5005.



GBP



Desk Drawer Sections BS1/05

Lockable drawer sections for desk mounting, with 110% pull-out and capacity 35 kg per drawer, total capacity is 175 kg distributed weight. Our 40mm table tops for work tables have bushings for direct mounting of drawer sections. For use with Ergomini, Ergomulti or lightweight work tables and packing tables with H-cabinet, mount the bucket with associated suspension profiles.

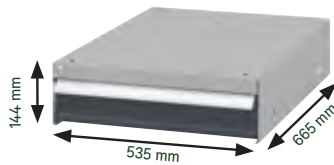

H x W x D (mm): 145 x 495 x 665
 Drawer height (mm): 100
 SKU 636285 . Price *

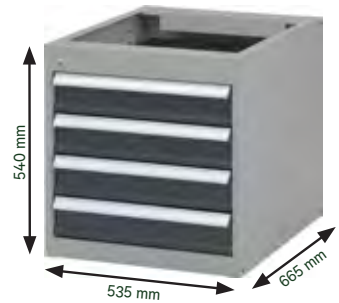

H x W x D (mm): 540 x 535 x 665
 Drawer height (mm): 100/100/100/100
 SKU 636274 . Price *



H x W x D (mm): 540 x 535 x 665
 Drawer height (mm): 50/150/200
 SKU 636304 . Price *



H x W x D (mm): 540 x 535 x 665
 Drawer height (mm): 50/100/100/150
 SKU 636256 . Price *

Suspension profiles for drawer sections

Suspension profiles used to mount drawer sections to our desks. Choose suspension profiles adapted to the table base you want, the profiles are priced and delivered in pairs.

	SKU	Price
For ErgoMulti	301867	*
For ErgoMini	635871	*
For Table 400	636129	*
For Table 400	636143	*
For H-stand, depth 585 mm	636242	*
For H-stand, depth 780 mm	636318	*



Drawer section VS1/05 Height 800 mm

Lockable bucket sections for standalone placement or as a table base. The drawers have 110% pull-out and capacity 35 kg per drawer, total capacity is 175 kg distributed weight. The drawer sections of series VS1/05 can be used as a table base together with a 40 mm table top, in combination with a base plate for side mounting that provides adjustable working height from 800 - 970 mm. If the bucket sections are to be used as free-standing tool storage - with or without a wheel chassis - the top plate is also to be ordered and preferably in combination with the rubber mat which provides a non-slip surface.

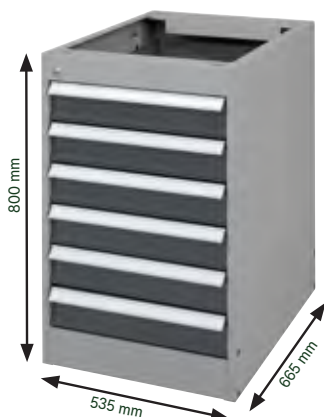

H x W x D (mm): 800 x 535 x 665
 Drawer height (mm): 6 x 100
 SKU 636308 . Price *



H x W x D (mm): 800 x 535 x 665
 Drawer height (mm): 50/100/150/300
 SKU 636287 . Price *



H x W x D (mm): 800 x 535 x 665
 Drawer height (mm): 50/100/100/150/200
 SKU 636310 . Price *



H x W x D (mm): 800 x 535 x 665
 Drawer height (mm): 50/100/150/150/150
 SKU 636280 . Price *



H x W x D (mm): 800 x 535 x 665
 Max. load (kg): 35
 SKU 636293 . Price *

Accessories for VS1/05 and BS1/05

Choose accessories for your drawer section for optimum workplace customization.

	W x D (mm)	SKU	Price
Top plate	540 x 670	636284	*
Side Mount Base Plate	350 x 670	636333	*
Rubber mat	530 x 660	301861	*
Chassis with wheels	155 x 540 x 670	636286	*
Drawer fixtures 4 troughs	150 x 150 x 27	396535	*
Drawer fixtures 3 troughs	150 x 150 x 27	396555	*
Drawer fixtures 2 troughs	150 x 150 x 27	396573	*
Partition of 396535	33	396574	*
Partition of 396555	45	396556	*
Partition of 396573	70	396516	*
Drawer Decor	65 x 450 x 605	301863	*



Drawer fixtures 2, 3, 4 troughs

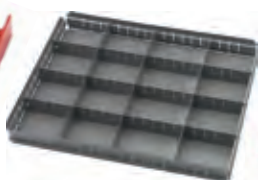

Accessory drawer section



Partition Wall



Chassis with wheels

Side Mount Base Plate

*) Contact Sono for prices

BS2 Desk Drawer Sections

GBP drawer sections for worktable and freestanding placement. Lockable drawer sections that are mounted in the table stand using suspension profiles, or screwed directly into a 40 mm table top. The desk drawer section is available in three heights and the free-standing drawer section in five heights. Hull RAL 9002, buckets RAL 5005.



GBP



Desk Drawer Sections BS2/03

Lockable drawer sections for desk mounting, with 100% pull-out and capacity 25kg per drawer. Our 40mm table tops for work tables have bushings for direct mounting of drawer sections. For use with Ergomini, Ergomulti or lightweight work tables and packing tables with H-cabinet, mount the bucket with associated suspension profiles to be ordered separately.



H x W x D (mm): 200 x 340 x 485
 Drawer height (mm): 150
 SKU 636322 . Price *



H x W x D (mm): 270 x 375 x 485
 Drawer height (mm): 100/100
 SKU 636320 . Price *



H x W x D (mm): 270 x 375 x 485
 Drawer height (mm): 50/150
 SKU 636291 . Price *



H x W x D (mm): 380 x 375 x 485
 Drawer height (mm): 100/100/100
 SKU 636305 . Price *



H x W x D (mm): 380 x 375 x 485
 Drawer height (mm): 50/100/150
 SKU 636334 . Price *



Drawer section BS2/03 Height 600 mm

Lockable bucket sections for standalone placement, with or without chassis w/wheels. The drawers have 100% pull-out and capacity 25 kg per drawer, total capacity is 100 kg distributed weight. For convenient drawer division, order drawer fixtures separately.

H x W x D (mm)	Drawer height (mm)	SKU	Price
600 x 375 x 485	50/100/100/100/150	636297	*

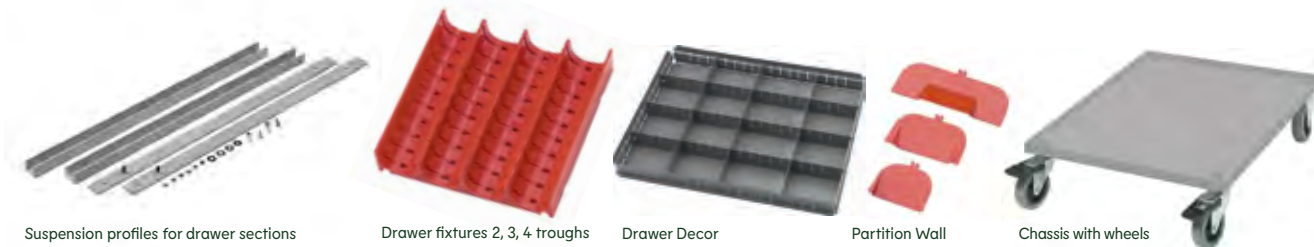

Suspension profiles for drawer sections

Drawer fixtures 2, 3, 4 troughs

Drawer Decor

Partition Wall

Chassis with wheels

Suspension profiles for drawer sections

Suspension profiles used to mount drawer sections to our desks. Choose suspension profiles adapted to the table base you want, the profiles are priced and delivered in pairs.

	Suitable for table depth (mm)	SKU	Price
For Table 400	800	636129	*
For Table 400	800	636143	*
For H-stand, depth 585 mm	620	636242	*
For H-stand, depth 780 mm	800	636318	*
For ErgoMini	800	635871	*

Accessories for BS2/03

Choose accessories for your drawer section for optimal customisation of your workspace.

	H x W x D (mm)	SKU	Price
Chassis with wheels	100 x 375 x 485	636292	*
Drawer Decor	65 x 305 x 450	301848	*
Drawer fixtures 2 troughs	150 x 150 x 27	396573	*
Drawer fixtures 3 troughs	150 x 150 x 27	396555	*
Drawer fixtures 4 troughs	150 x 150 x 27	396535	*
Partition of 396535	33	396574	*
Partition of 396555	45	396556	*
Partition of 396573	70	396516	*



Cabinet section on wheels

Cabinet section on wheels with lockable door and 1 shelf, as well as rubber mat on the top plate. The dimensions of the door are 630 x 470 mm. This combination consists of the following products: 1 pc. top plate 540 x 670 mm, 1 pc. rubber mat 530 x 660 mm, 1 pc. chassis with wheels, 4 swivels, of which 2 with brakes, Ø125 mm, 1 pc. cabinet section VS1, 800 x 535 x 665 mm.

Height (mm)	800		
Weight (kg)	40		
W x D (mm)	SKU	Price	
565 x 660	636785		*



Drawer section with 4 drawers

Drawer section on wheels with 4 drawers and rubber mat on the top plate. It has central locking and ball bearings that provide 110% extraction. The drawers are secured so that only 1 drawer can be opened at a time. 1 x 50 mm / 1 x 100 mm / 1 x 150 mm / 1 x 300 mm. Total capacity 175 kg distributed weight, and 35 kg per drawer. This combination consists of the following products: 1 pcs. Top plate 540 x 670 mm, 1 pc. Rubber mat 530 x 660 mm, 1 pc. Chassis with wheels, 4 swivel, of which 2 with brakes, Ø125 mm, 1 pc. Drawer section VS1, 800 x 535 x 665 mm, internal drawer dimensions 450 x 605 mm.

Internal drawer w x d (mm)	450 x 605		
Drawer height (mm)	50/100/150/300		
Load (kg)	35		
Colour	Grey RAL7004 / Dark grey RAL7024		
Weight (kg)	72		
W x D (mm)	SKU	Price	
565 x 660	637046		*

*) Contact Sono for prices

Floor racks and trolleys

Floor stand that can be placed individually or together in full lengths.

Our accessories range also fits the interior system, making it to a flexible system that fits most areas. With the help of mobile carts, you can easily move components / tools to and from the workplace. Complete our trolleys with accessories according to your needs.

Colour light grey RAL 9002 and blue RAL 5005.

GBP

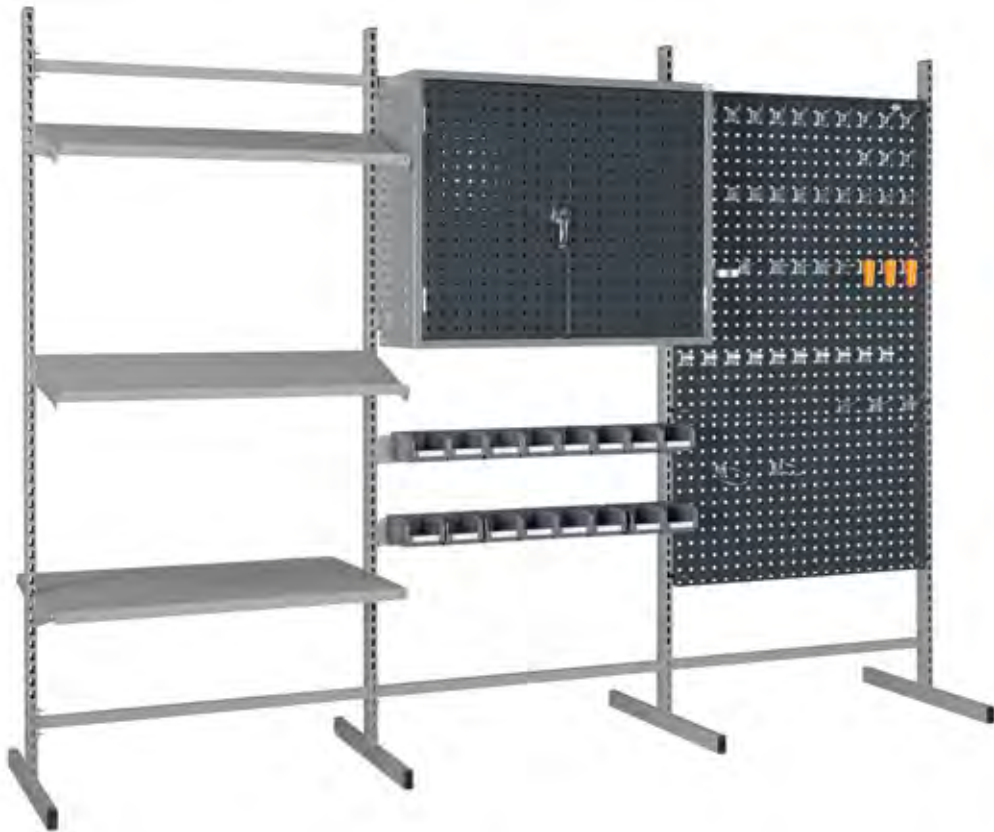

Complete Floor Stand – Combination 5

Combination 5 consists of 3 bays of floor shelving w/T-foot and includes 3 tool boards h x w = 480 x 870 mm, 1 perforated tool cabinet, 2 suspension strips including 16 grey storage boxes 2075, 2 shelves w/depth 300 mm and 1 shelf w/depth 613 mm.

Max. load distributed (kg)	350
H x W x D (mm)	SKU
2000 x 2725 x 610	636923
	Price
	*

Floor stand start and additional sections

Starting and additional sections of floor stand, with L- or T-foot. The sections are supplied complete with base, columns and intermediate struts. Supplement with shelves, tool boards, suspension strips etc. for CC900 mm.

	H x W x D (mm)	Max. load distributed (kg)	SKU	Price
L-foot start section	1500 x 925 x 415	150	636750	*
L-foot auxiliary section	1500 x 900 x 415	100	636706	*
L-foot start section	2000 x 925 x 415	150	636842	*
L-foot auxiliary section	2000 x 900 x 415	100	636707	*
T-foot start section	1500 x 925 x 610	150	636911	*
T-foot auxiliary section	1500 x 900 x 610	100	636751	*
T-foot start section	2000 x 925 x 610	150	636912	*
T-foot auxiliary section	2000 x 900 x 610	100	636708	*

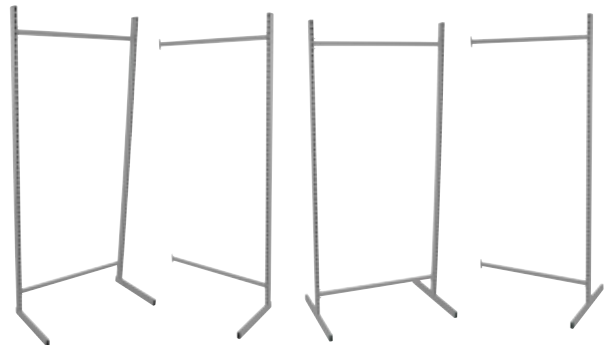



Complete Floor Stand - Combination 1

Combination 1 consists of 2 bay floor racks w/T-foot and includes 2 pcs toolboards h x w = 480 x 870 mm and 2 pcs suspension strips including blue stock boxes - 4 pcs 2067, 6 pcs 2074 and 8 pcs 2075.

Max. load distributed (kg)	250	
H x W x D (mm)	SKU	Price
2000 x 1580 x 610	636798	*



Complete Floor Stand - Combination 2

Combination 2 consists of 2 bay floor racks w/T-foot and includes 2 pcs toolboards h x w = 480 x 870 mm, 1 pcs whiteboard h x w = 480 x 870 mm and 3 pcs suspension strips including blue stock boxes - 4 pcs 2067, 6 pcs 2074 and 8 pcs 2075.

Max. load distributed (kg)	250	
H x W x D (mm)	SKU	Price
2000 x 1580 x 610	636922	*



Complete Floor Stand - Combination 3

Combination 3 consists of 2 bay floor racks w/T-foot and includes 3 pcs toolboards h x w = 480 x 870 mm, whiteboard h x w = 480 x 870 mm, 1 shelf and 3 pcs suspension strips - including red stock boxes - 8 pcs 2067, 6 pcs 2074 and 8 pcs 2075.

Max. load distributed (kg)	250	
H x W x D (mm)	SKU	Price
2000 x 1580 x 610	636829	*



Complete Floor Stand - Combination 4

Combination 4 consists of 2 compartments floor racks w/T-foot and includes 1 pcs tool board h x w = 480 x 870 mm, 1 pcs perforated tool cabinet, 1 shelf and 3 pcs suspension strips - including red stock boxes - 8 pcs 2067, 6 pcs 2074 and 8 pcs 2075.

Max. load distributed (kg)	250	
H x W x D (mm)	SKU	Price
2000 x 1580 x 610	636879	*



Assembly trolley - combination 1

Complete assembly trolley combination 1, on T-column with bottom shelf and 4 pcs stock boxes 2073, tool panel h x w = 480 x 870 mm and suspension rail with 8 pcs stock boxes 2075. The assembly trolley has 2 Ø125 mm castors, 2 of which are lockable. The total capacity is 150 kg.

Max. load distributed (kg)	150	
No. of stock cans	12	
H x W x D (mm)	SKU	Price
1655 x 920 x 615	636843	*



Assembly trolley - combination 2

Complete assembly trolley combination 2, on T-column with bottom shelf, 3 pcs shelves d = 615 mm, 300 mm and 210 mm, as well as tool panel h x w = 480 x 870 mm and suspension rail without stock boxes. The assembly trolley has 2 Ø125 mm castors, 2 of which are lockable. The total capacity is 150 kg.

Max. load distributed (kg)	150	
Number of shelves (pcs)	3	
H x W x D (mm)	SKU	Price
1655 x 920 x 615	636769	*



Assembly trolley - combination 3

Complete assembly trolley combination 3, on T-column with bottom shelf including 3 pcs tool panel h x w = 480 x 870 mm. The assembly trolley has 2 Ø125 mm castors, 2 of which are lockable. The total capacity is 150 kg.

Max. load distributed (kg)	150	
Number of shelves (pcs)	1	
H x W x D (mm)	SKU	Price
1655 x 920 x 615	636953	*



Assembly trolley - combination 4

Complete assembly trolley combination 4, on T-column with bottom shelf and 6 pcs suspension rails with a total of 48 pcs. stock boxes 2075. The assembly trolley has 2 Ø125 mm castors, 2 of which are lockable. Handle included. The total capacity is 150 kg.

Max. load distributed (kg)	150	
Number of shelves (pcs)	1	
H x W x D (mm)	SKU	Price
1655 x 920 x 615	636709	*

Accessories for floor racks and trolleys

GBP

GBP Ergonomics is our own brand for furnishing ergonomic workplaces for industry, workshops and warehouses. GBP was established in 1905 and is today one of Scandinavia's leading manufacturers of work tables, cabinets, drawers and industrial chairs for people who want an ergonomic and functional working day.

Perforated tool cabinet

Plastic Boxes

Perforated column with height 1446 mm

Shelf

T-Foot



Floor stand with L- or T-foot

Feet combined with our perforated columns for the construction of floor mounted stands. The L- or T-foot is combined with columns of the desired height and 2 spacers before the desired width. Capacity is 100kg for L-foot and 150kg for T-foot, with evenly distributed load.

	Max. load distributed (kg)	SKU	Price
L-foot 420 mm	100	636328	*
T-foot 610 mm	150	636336	*

Perforated Columns

Perforated columns for fixing at the back of packing and work tables, for use with our rich range of accessories. The columns consist of profiles of 25x50 mm. The net height above the table top is approximately 400 mm less than the column height (depending on the thickness of the table top). Mounting kit must be ordered in addition, 1 kit per column.

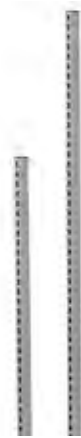

SKU	Price
Column 1-pack, height 1446 mm 634475	*
Column 1-pack, height 1926 mm 634480	*

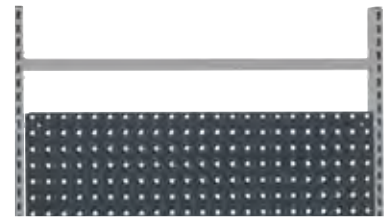

Intermediate stay

For increased stability of the superstructure, the use of spacers is recommended.

Length (mm)	SKU	Price
645	634482	*
875	634483	*
1315	636290	*
1775	636307	*



Tool Panel

Perforated tool board with 9 mm square hole with cc dimensions 38 mm. With the included mounting kit, the boards are easily mounted in columns on work tables, on wall rails or on mounting trolleys. The boards can also be mounted directly on the wall.

W x H (mm)	CC dimensions (mm)	SKU	Price
640 x 480	670	634485	*
870 x 480	900	634486	*



Perforated tool cabinet D120

Lockable tool cabinet for use with perforated columns on work tables or assembly trailers. With both doors open, the cabinet expands into a practical tool board with a full 2 m width. The cabinet is perforated with 9 mm square holes with cc dimensions 38 mm.

W x D x H (mm)	Lock Type	SKU	Price
870 x 120 x 475	Key lock	636295	*



Perforated tool cabinet D250

Lockable tool cabinet for use with perforated columns on work tables or assembly trailers, alternatively the cabinet can be hung directly on the wall. The cabinet is perforated with 9 mm square holes with 38 mm cc dimensions and mounting brackets for columns included. Lock Type: Cylinder lock

W x D x H (mm)	SKU	Price
870 x 250 x 715	636312	*
Extra shelf	636235	*



Magnetic whiteboard

Boards used as whiteboards and/or magnetic boards for use with perforated columns on work tables or assembly carts, alternatively the boards can be hung directly on the wall

H x W (mm)	SKU	Price
480 x 640	301476	*
480 x 870	301477	*



Suspension rail

Suspension rail for plastic storage boxes, comes with integrated brackets for straight or angled mounting, in columns on work tables, on wall rails or on mounting trolleys. Capacity is 20 kg distributed weight.

H x W (mm)	SKU	Price
80 x 670	634472	*
80 x 900	634473	*
80 x 1340	636219	*
80 x 1800	636269	*

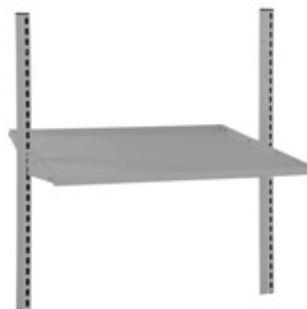

Storage shelves

Shelves with suspension brackets for correct placement in columns on work desks or on assembly trailers. The shelves have curved edges on all four sides and have a capacity of 50 kg distributed load. As an option, an additional grooved rubber mat is ordered for less noise and non-slip storage on the shelf.

W x D (mm)	SKU	Price
875 x 613	634464	*
870 x 610	301485	*



Storage shelves

Shelves with suspension brackets for straight or inclined placement in columns on work tables, on wall rails or on assembly trolleys. The shelves can be placed with a wobble edge at the front or rear and have a capacity of 50 kg distributed load.

W x D (mm)	SKU	Price
645 x 300	634470	*
875 x 300	634478	*
875 x 457	634469	*

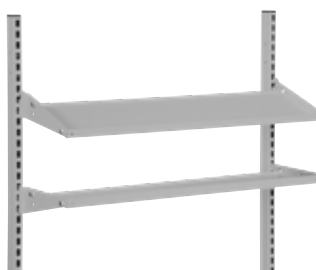

Storage shelves

Shelves with suspension brackets for correct placement in columns on work desks or on assembly trailers. The shelves have curved edges on all four sides and have a capacity of 50 kg distributed load. As an option, an additional grooved rubber mat is ordered for less noise and non-slip storage on the shelf.

W x D (mm)	SKU	Price
645 x 210	634455	*
645 x 450	634454	*
875 x 210	634453	*
875 x 613	634464	*



Shelf dividers

Shelf divider for use as a binder support, side support or other type of shelf divider. The dividers are supplied in 2-pack, are adapted to shelves with a depth of 300 mm and are supplied in 2 heights.

H x D (mm)	SKU	Price
Height 200 mm	636344	*



Storage shelves

Shelves with suspension brackets for correct placement in pillars on packing and work tables or on assembly and packing trolleys. The shelves have a capacity of 35 kg distributed load.

W x D (mm)	SKU	Price
1800 x 300	635177	*
1350 x 300	636331	*



Additional handle
SKU 636324. Price *

Assembly trolley BASIC

Base model of mounting trolley, for module accessories with CC 900 mm. The trolley consists of a bottom shelf, perforated columns with a height of 1446 mm, intermediate strut CC 900, handle and 4 swivel Ø125 mm wheels of which 2 have brakes. In addition, a grooved rubber mat can be selected for the bottom shelf as well as additional handles for easy operation from two sides.

H x W x D (mm)	SKU	Price
1655 x 900 x 615	636841	*



*) Contact Sono for prices



ErgoDouble workshop cabinet

ErgoDouble is a lockable and highly versatile workshop cabinet that comes with an internal shelf and 2 pull-out drawers. Each drawer has internal dimensions 90 x 340 x 400 mm and capacity 20 kg. As an accessory, you can order extra shelf for interior placement, rubber mat or the practical wheel chassis with Ø75 mm swivel wheels.

	W x D (mm)	SKU	Price
Complete, as depicted	950 x 450 x 995	636787	*
Rubber mat	940 x 440	301588	*
Shelf	25	640745	*
Undercarriage	100	640746	*
Tool cabinet	950 x 450 x 900	640744	*



ErgoLite workshop cabinet

ErgoLite is a lockable and very useful small workshop cabinet that comes with an internal shelf and pull-out drawer. The drawer has internal dimensions 90 x 340 x 400 mm and capacity 20 kg. As an accessory, you can order inclined top /memoboard, extra shelf for interior placement, rubber mat or the practical wheel chassis with Ø75 mm swivel wheels.

	W x D (mm)	SKU	Price
Complete, as depicted	500 x 450 x 995	636918	*
Rubber mat	490 x 440	301583	*
Shelf	25	640749	*
Undercarriage	100	640747	*
Memoboard	500 x 450 x 280	640750	*
Tool cabinet	500 x 450 x 900	640748	*

639211



SME Tool Trolley

This tool trolley has lacquered wooden board w/steel edge all around as a work top. The trolley comes in two options; with a cabinet section with removable shelf, as well as 5 pull-out drawers, alternatively with 2 x 5 drawers. Comes with cylinder lock for both cabinets and drawers. Two fixed and two swivel wheels, the swivel ones have brakes.

H x W x D (mm)	930 x 960 x 600	
Colour	Grey RAL7004 / Dark grey RAL7024	
Max load evenly distributed weight (kg)	325	
Max Load Weight/Bucket (kg)	40	
Internal dimensions drawers (mm)	90/205 x 370 x 515	
	SKU	Price
2 x 5 drawers	639211	*
Cabinets and 5 drawers	634501	*



636863

634500

SME Trolley Tool Board

Do you want more efficient use of the tool trolley? With the tool board attached to the trolley, you get even easier access to the tools you use often. Then choose between the locking and raising and lowering tool board or the fixed board. The height adjustable tool board has a light opening of h x w x d = 505 x 740 x 65 mm.

Colour	Dark grey RAL7024	
	SKU	Price
Fixed tool board	636863	*
Height-adjustable tool board	634500	*

GBP



Ergonomics tool trolley

Convenient and easy to drive tool trolley that comes with or without tool hooks for 109 hand tools. Ergonomics has 4 Ø100 mm swivelling castors, 1 of which has a brake. Bottom shelf is included, in addition, additional shelf can be ordered for placement under the tool cabinet. Prepared for padlock locking.

	H x W x D (mm)	SKU	Price
Incl. tool hooks	1490 x 600 x 400	637039	*
Excl. tool hooks	1490 x 600 x 400	636325	*
Extra shelf under cupboard	600 x 400	636234	*



Trolley Basic

Sturdy and practical roller table, consisting of table top with w x d = 800 x 620 mm on a height-adjustable steel chassis, which provides a working height of 765 x 1025 mm. The trolley has a table top of HPL. The table has 4 pcs Ø125 mm swivel castors, two of which are lockable. Capacity is 200 kg.

W x D (mm)	800 x 620	
Load (kg)	200	
	SKU	Price
Roller table with bodywork	636819	*
Trolley	636756	*
Attachment Frame Mounting Kit	435838	*
Attachment frame	636840	*



GBP Tool trolley

These workshop trolleys have a table top consisting of a chip core coated with oak parquet and with a steel edge around it. The trolleys are equipped with two swivel wheels with brakes and two fixed wheels without brakes, Ø160 mm. Comes in two versions, one with cabinet with lockable door and movable shelf, or with two drawer sections with five drawers each. The drawers are equipped with powerful slides that provide 110% expansion, and have drawer latch and central locking.

H x W x D (mm)	925 x 955 x 600
Weight (kg)	100
Colour	Grey RAL7004 / Dark grey RAL7024
Load (kg)	350
Load per drawer (kg)	40
Internal dimensions drawers 4 pcs (mm)	350 x 415 x 85
Internal dimensions drawers 1 pcs (mm)	350 x 415 x 185

	SKU	Price
2 x 5 drawers	636276	*
Cabinets and 5 drawers	636213	*



Attachment kit complete for GBP workshop trolley

The attachment kit consists of 2 perforated columns (H=820 mm, with brackets for mounting on the underside of the table top), 1 pc. perforated tool panel, 1 pc. rail for hanging plastic boxes and 1 pc. shelf 875 x 210 mm. The superstructure can also be supplemented with several shelves.

SKU	636742	Price	*
-----	--------	-------	---

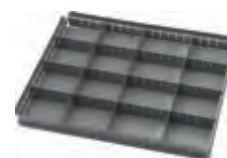

Drawer Decor

Drawer fittings in steel. 3 longitudinal and 3 transverse partition plates are included for optional placement in the slots sidewalls.

H x W x D (mm)	Material	SKU	Price
90 x 347 x 415	Steel	431772	*



Maxi Tool Storage

Maxistore is a compact storage package with large storage space for tools, in only 2 m² of floor space. This form of tool storage saves a lot of space. With support wheels at the front and a sturdy handle, it's easy to operate. Maximum load is 800 kg, 120 kg per plate. The maximum number of discs in Maxistore is 14, so please add more discs for even more compact storage. Tools and hooks are not included. This gives you full control of the tool. H x w x d = 2160 x 1050 x 1860 mm.

	SKU	Price
Maxi size with 4 tool plates	636139	*
Additional panel complete	636178	*

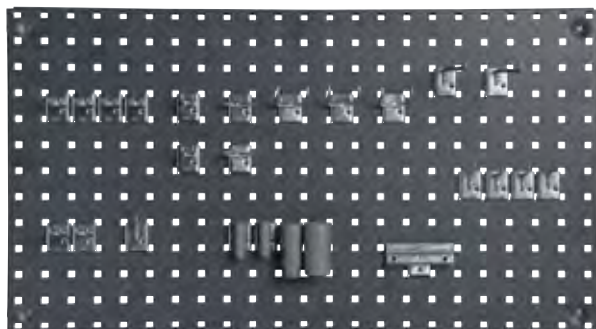

301655

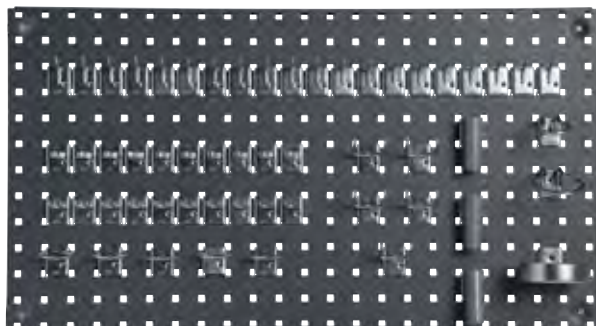

301656

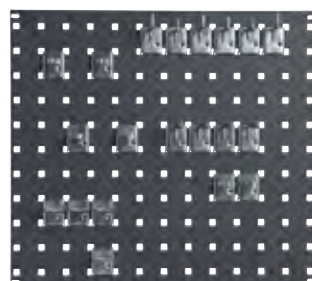

301654

Wall tool plate

Suspension toolboard directly on the wall. The board is perforated with 9 x 9 mm holes with CC 38 mm.

H x W (mm)		SKU	Price
450 x 1000		635174	*
450 x 2000		635173	*
950 x 1000	Dark grey RAL7024	635175	*
950 x 1500		635178	*
950 x 2000		635176	*

Assorted Selection Hook Set

Hook set with assorted selection of the most commonly used tool hooks. Suitable for tool boards with 9 mm square hole CC 38 mm.

	Size (mm)	pcs.	SKU	Price
20 hooks	44 x 23	20	301654	*
24 hooks	43 x 20	24	301655	*
56 hooks	65 x 35	56	301656	*



Fixing Plate

Our range of tool hooks consists of around 50 variants for different applications. The tool hooks hook into our perforated tool boards and lock with a stop screw. All tool hooks are adapted to our boards, whether they are mounted in cabinets, on trolleys or on work desks. The tool hooks are adapted for boards with 9 mm square holes with hole spacing CC38 mm.

	pcs.	SKU	Price
34 x 40	5	301631	*



Utensil Holder

The holder simplifies the storage of tools with shafts both outside and inside. Priced and delivered in packs of 2

	W x D x H (mm)	SKU	Price
B60xH35xD40 mm	60 x 35 x 40	396547	*
B60xH35xD65 mm	60 x 35 x 65	436097	*



Scroll holder

Roller holder intended for suspension of various rollers. Supplied in 1 pc.

	Pack (per space)	SKU	Price
100x80x45mm	1	396532	*
200x105x45mm	1	396551	*



Wire shelf

Wire shelf 100 x 385 x 180 mm for hanging in tool board. Powder coated in RAL 9006. Priced and delivered in packs of 1

Pack (per space)	SKU	Price
1	396550	*



Document Clamp

Document clip 60 mm for hanging in tool board. Priced and delivered in packs of 1

	SKU	Price
60 mm	396567	*

*) Contact Sono for prices



Single hook

Size (mm)	pcs.	SKU	Price
Ø6 x 10	5	301612	*
Ø6 x 50	5	301613	*



Single Angled Hook

Size (mm)	pcs.	SKU	Price
Ø4 x 50	5	301608	*
Ø6 x 100	5	301609	*



Angle hook

Size (mm)	pcs.	SKU	Price
Ø5 x 50 x 40	5	301604	*



Articulating Wrench Hook

Size (mm)	pcs.	SKU	Price
Ø3, 28 x 10/9	5	301610	*
Ø3, 33 x 17/9	5	301611	*



Spring Clamp

Size (mm)	pcs.	SKU	Price
Ø6	5	396546	*
Ø12	5	396566	*
Ø18	5	301649	*
Ø25	5	301650	*



Hanger hook

Size (mm)	pcs.	SKU	Price
Ø5, 23x44	5	301603	*
Ø4, 20x43	3	396531	*
Ø4, 35x65	3	396588	*



Closed double hook

Size (mm)	pcs.	SKU	Price
Ø5, 70 x 25	5	301614	*



Packing Hook

Size (mm)	pcs.	SKU	Price
Ø4 x 165	5	301602	*



Ring hook ISO40

Size (mm)	pcs.	SKU	Price
Ø45 x 115	5	301605	*



Pipe Holder

Size (mm)	SKU	Price
Pipe holder 2xØ25mm and 1xØ37mm	102499	*
Pipe holder 50x9mm, 2 pcs	396548	*
Pipe holder 75x16mm, 2 pcs	396533	*
Pipe holder 75x24mm, 2 pcs	396568	*
Pipe holder 70x35mm, 2 pcs	396549	*



Hanger hook

Size (mm)	pcs.	SKU	Price
Ø60	5	301606	*
Ø80	5	301607	*



Ring Hooks

Size (mm)	pcs.	SKU	Price
Ø40	5	301651	*
Ø60	5	301652	*
Ø80	5	301653	*



Spray can holder

Size (mm)	pcs.	SKU	Price
Ø75 x 100	1	301600	*



Cup

Size (mm)	pcs.	SKU	Price
Ø104, H23	1	301641	*



Box Holder

Size (mm)	pcs.	SKU	Price
105 x 45	5	301642	*
105 x 45	5	301643	*



Single Suspension Hook

Size (mm)	pcs.	SKU	Price
Ø3 x 22	5	301629	*
Ø5 x 24	5	301624	*
Ø5 x 38	5	301625	*
Ø5 x 150	5	301627	*
Ø4 x 47	5	301630	*
Ø6 x 100	5	301626	*
Ø6 x 200	5	301628	*

Double suspension hook

Size (mm)	pcs.	SKU	Price
Ø5, 38 x 8	5	301615	*
Ø5, 38 x 11	5	301616	*
Ø5, 55 x 25	5	301617	*
Ø5, 64 x 8	5	301618	*
Ø5, 64 x 11	5	301619	*
Ø6, 100 x 25	5	301620	*
Ø5, 150 x 10	5	301621	*
Ø5, 150 x 25	5	301622	*
Ø6, 200 x 15	5	301623	*



Articulating wrench holder

Size (mm)	pcs.	SKU	Price
150	1	301636	*



Drill holder

Size (mm)	pcs.	SKU	Price
240	1	301637	*

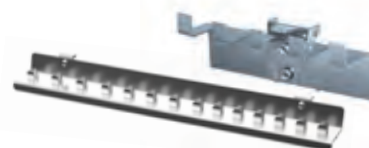

Socket holder

Size (mm)	pcs.	SKU	Price
127	1	301634	*
250	1	301635	*



Screw iron holder

Size (mm)	pcs.	SKU	Price
150	1	301638	*
220	1	301639	*
238	1	301640	*



Hose holder

Pack (per space)	SKU	Price
1	301598	*



Shelf

Size (mm)	SKU	Price
350 x 120	301599	*



Fixed key list

Size (mm)	pcs.	SKU	Price
150	1	301632	*
250	1	301633	*



Fixed key holder

Size (mm)	pcs.	SKU	Price
235 x 65-145	1	301601	*



Key holder

Size (mm)	pcs.	SKU	Price
555	1	301597	*

*) Contact Sono for prices

Tools & Workshop Cabinets

In our range you will find good cabinet solutions – steel cabinets adapted to every need and desire.

Here you will find a large selection of workshop tools to help you keep track of tools, utensils, papers and other equipment that should be stored in a safe place.



Perforated tool cabinet D250

Lockable tool cabinet for use with perforated columns on work tables or assembly trailers, alternatively the cabinet can be hung directly on the wall. The cabinet is perforated with 9 mm square holes with 38 mm cc dimensions and mounting brackets for columns included.

	W x D x H (mm)	SKU	Price
Tool cabinet	870 x 250 x 715	636312	*
Extra shelf		636235	*
Hull Color		Grey RAL7004	
Door Color		Dark grey RAL7024	
Lock Type		Cylinder lock	
Ant. shelves		-	
Weight (kg)		25	

GBP

Perforated tool cabinet

Perforated cabinet for wall mounting. The cabinet comes without fittings and is perforated with 9 mm square holes with CC 38 mm, adapted for use with our tool hooks. The doors are prepared for padlock locking.

H x W x D (mm)	790 x 600 x 400
Hull Color	Grey RAL7004
Door Color	Dark grey RAL7024
Lock Type	Padlock
Ant. shelves	-
Weight (kg)	27

SKU	Price
636940	*

Prepared for wall mounting, BoxIT is designed for convenient storage of small parts and other equipment. The cabinets are lockable with cylinder lock and adapted for use with our rich selection of storage boxes, see table for the number and type of boxes per cabinet. BoxIT enclosures are delivered fully assembled (without boxes). Capacity is 75 kg per cabinet and 15 kg per shelf.



Nr. 1



Nr. 2



Nr. 3

BoxIT Storage Cabinet

	H x W x D (mm)	Ant. shelves	SKU	Price
No 1	380 x 470 x 205	3	636329	*
No 2	580 x 470 x 205	5	636335	*
No 3	800 x 660 x 275	5	636300	*



No. 3075 D x W x H (mm) 170 x 105 x 75

		SKU	Price
Blue	1 pcs.	619983	*
Red	1 pcs.	619984	*
Yellow	20 pcs.	619985	*
Green	20 pcs.	619923	*
Grey	20 pcs.	619982	*

The price per item. See packaging for current order quantity.



No. 3074 D x W x H (mm) 250 x 148 x 130

		SKU	Price
Blue	1 pcs.	619979	*
Red	1 pcs.	619980	*
Yellow	36 pcs.	619981	*
Green	36 pcs.	619922	*
Grey	36 pcs.	619978	*

The price per item. See packaging for current order quantity.



BoxIT fridge freezer

The BoxIT fridge freezer is prepared for wall mounting and is designed for convenient storage of tools, small parts and other equipment. The cabinets are lockable with cylinder lock and adapted for use with our rich range of tool hooks and storage boxes. BoxIT combi enclosures are delivered fully assembled (without boxes) with 2 fixed shelves, perforated back and door (9 mm square hole CC 38 mm). Capacity is 75 kg per cabinet and 15 kg per shelf.

	H x W x D (mm)	SKU	Price
BoxIT combi	580 x 470 x 205	636309	*



No. 2076 D x W x H (mm): 96 x 105 x 45

Colour	Pack	SKU	Price
Yellow	1 pcs.	110043	*
Red	1 pcs.	110044	*
Blue	1 pcs.	110045	*
Transparent grey	1 pcs.	110046	*



GBP workshop cabinet, complete with fittings

Workshop cabinet with robust construction and three-point lock. The cabinet is equipped with four vertical perforated rails for mounting accessories. The cabinet has double steel doors with handle and lock. Supplied complete with

- 1 drawer section with 6 drawers
- 1 pull-out shelf
- 2 shelves 100kg
- 1 pull-out drawer
- 1 tool plate, back
- 2 tool plates, cabinet side
- 1 tool plate, door
- 1 suspension rail
- 24 assorted tool hooks
- 7 blue storage boxes 96x105x45.

Hull Color	Grey RAL7004
Door Color	Dark grey RAL7024
SKU	636960
Price	*

GBP workshop cabinet

GBP is a series of fully welded workshop cabinets with good cabinet depth, adapted to the storage of tools and equipment, in the workshop, in stock or in other parts of the business. The cabinets have 3-point espagnolette locking with cylinder or RFID locking. To use RFID lock, order card pack SM02555-CARD-01 containing programming cards, service cards, and Mode 2, 3, 4, and 5 cards - 1 per plant. The cabinet is delivered without shelves, these are ordered separately. Basically, the cabinet is delivered without accessories, and by choosing from our wide range of equipment that fits these cabinets, you can get a practical storage solution just the way you want it. Capacity is 500 kg distributed weight per cabinet.

Hull Color	Grey RAL7004		
Door Color	Dark grey RAL7024		
Antf. shelves	Accessories		
Max load/cabinet (kg)	500		

W x D x H (mm)	Key lock L-handle		RFID Lock	
	SKU	Price	SKU	Price
1020 x 540 x 1070	636319	*	636926	*
1020 x 540 x 1500	636266	*	636919	*
1020 x 540 x 2000	636283	*	636777	*



RFID Lock





GBP workshop cabinet w/plexi doors

GBP is a series of fully welded workshop cabinets with good cabinet depth, adapted to the storage of tools and equipment, in the workshop, in stock or in other parts of the business. The cabinets have plexiglass doors and 3-point locks - with cylinder or RFID locks. For use with RFID, order card pack SM02555-CARD-01 containing programming cards, service cards and cards for Mode 2, 3, 4 and 5 - 1 per plant. Basically, the cabinet is delivered without accessories, and by choosing from our wide range of equipment that fits these cabinets, you can get a practical storage solution just the way you want it. Capacity is 500 kg distributed weight per cabinet.

H x W x D (mm)	2000 x 1020 x 540
Hull Color	Grey RAL7004
Door Color	Dark grey RAL7024
Door type	Steel and Plexiglass
Ant. shelves	Accessories
Max load/cabinet (kg)	500

Lock Type	SKU	Price
Key lock L-handle	636264	*
RFID Lock	637047	*



GBP

Accessories
GBP workshop cabinet

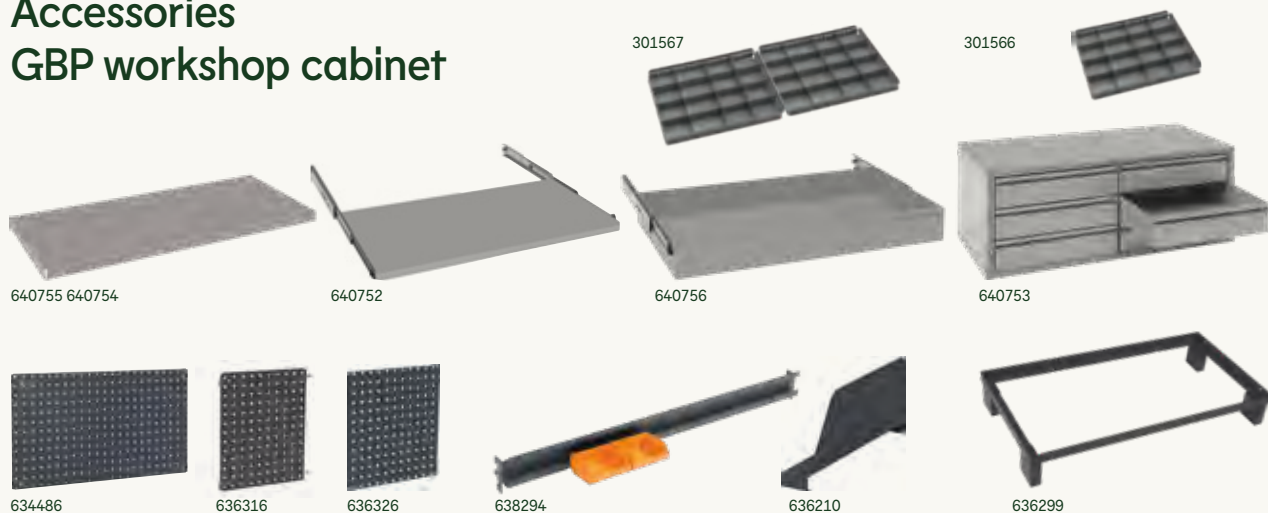

	Size (mm)	SKU	Price
Shelf capacity 50 kg, 2-pack	974 x 440	640755	*
Shelf capacity 100 kg, 2-pack	974 x 440	640754	*
Pull-out shelf 25kg, 110% pull-out	875 x 455	640752	*
Drawer section 50kg, 110% pull-out	875 x 445 x 100	640756	*
Drawer section with 6 drawers	360 x 970 x 450	640753	*
Drawer Decor Small Drawers	440 x 440 x 65	301566	*
Drawer fixtures pull-out drawer	875 x 440 x 65	301567	*

	Size (mm)	SKU	Price
Tool board CC900mm	870 x 480	634486	*
Tool board CC670mm	640 x 480	634485	*
Door tool panel	475 x 430	636316	*
Tool panel cabinet side, 2-pack	479 x 378	636326	*
Suspension rail chap. 20 kg	900 x 80	638294	*
Separator plate, 2-pack	175 x 440	636210	*
Truck base	1020 x 540	636299	*

*) Contact Sono for prices



SMV Tool Cabinet- combination 1

Tool cabinet combination 1 is based on a solid, fully welded steel cabinet with a light grey RAL7004 body and dark grey RAL7024 doors. The cabinet combination contains the following: - 4 pcs. removable shelves - 2 pcs. removable drawers - 1 pcs. tool board for back - 2 pcs. tool boards for door - 1 pcs. hook set w/45 hooks - 5 pcs. storage boxes 2013 - 10 pcs. storage boxes 2011

Hull Color	Grey RAL7004
Door Color	Dark grey RAL7024
SKU	636992
Price	*

GBP



SMV Tool cabinet- combination 2

Tool cabinet combination 2 is based on a solid, fully welded steel cabinet with a light grey RAL7004 body and dark grey RAL7024 doors. The cabinet combination contains the following: - 4 pcs. removable shelves - 1 pcs. removable drawer - 1 pcs. tool board for back - 2 pcs. tool boards for door - 1 pcs. hook set w/45 hooks - 4 pcs. storage boxes 2068 blue - 4 pcs. storage boxes 2068 red

Hull Color	Grey RAL7004
Door Color	Dark grey RAL7024
SKU	636978
Price	*



SMV Tool cabinet- combination 3

Tool cabinet combination 3 is based on a solid, fully welded steel cabinet with a light grey RAL7004 body and dark grey RAL7024 doors. The cabinet combination contains the following: - 4 pcs. removable shelves - 1 pcs. removable drawer - 1 pcs. tool board for back - 2 pcs. tool boards for door - 1 pcs. hook set w/45 hooks

Hull Color	Grey RAL7004
Door Color	Dark grey RAL7024
SKU	636979
Price	*

SMV Tool cabinet- combination 4

Tool cabinet combination 4 is based on a solid, fully welded steel cabinet with a light grey RAL7004 body and dark grey RAL7024 doors. The cabinet combination contains the following: - 5 pcs. removable shelves - 1 pcs. tool board for back - 2 pcs. tool boards for door - 1 pcs. hook set w/45 hooks - 8 pcs. storage boxes 2068 blue - 8 pcs. storage boxes 2068 red

Hull Color	Grey RAL7004
Door Color	Dark grey RAL7024
SKU	636994
Price	*



SMV Tool cabinet- combination 5

Tool cabinet combination 5 is based on a solid, fully welded steel cabinet with a light grey RAL7004 body and dark grey RAL7024 doors. The cabinet combination contains the following: - 6 pcs. removable shelves - 8 pcs. storage boxes 2068 blue - 8 pcs. storage boxes 2068 red

Hull Color	Grey RAL7004
Door Color	Dark grey RAL7024
SKU	636995
Price	*



SMV tool cabinet

GBP





SMV tool cabinet

A range of highly durable, fully welded tool cabinets that meet your storage needs in the workshop, warehouse or production. Load per shelf is as much as 100 kg.

Hull Color	Grey RAL7004
Door Color	Dark grey RAL7024

H x W x D (mm)	Number of shelves	Max Load/Shelf (kg)	SKU	Price
500 x 435 x 1040	2	100	622511	*
1040 x 1000 x 435	2	100	635880	*
1990 x 1000 x 600	4	100	635881	*
1990 x 1000 x 435	4	100	635885	*



SMV Chemical Cabinet

A series of fully welded chemical cabinets for industry, schools and public administration, with hinged doors w/cylinder locks. The cabinet comes complete with removable, galvanized shelves that have edges for collecting any chemical spills. The cabinet has ventilation valves and Ø100 mm ventilation socket at the top for connection to external ventilation.

H x W x D (mm)	Door Color	Number of shelves	SKU	Price
1040 x 1000 x 435	Dark grey RAL7024	2	635879	*
1990 x 1000 x 435	Dark grey RAL7024	4	635882	*
Extra shelf			101076	*

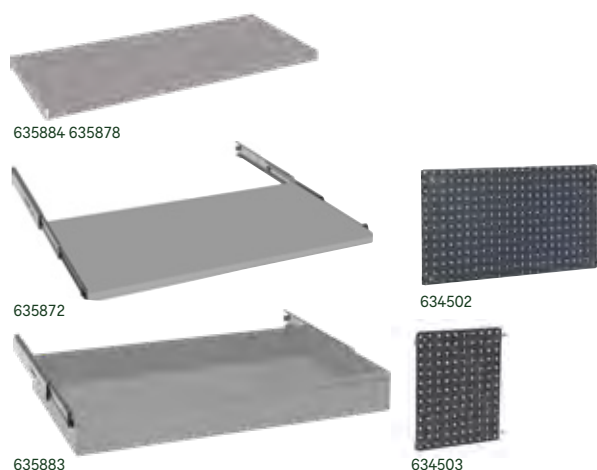

Workshop cabinet accessories

Beskrivelse	Size (mm)	Colour	Max Load/Shelf (kg)	SKU	Price
Tool Cabinet Shelf	995 x 370		100	635884	*
Tool Cabinet Shelf	995 x 535		100	635878	*
Drawer Shelf	895 x 370	Grey RAL7004	40	635872	*
Retractable drawer for tool cabinet	995 x 535		25	635883	*
Tool panel tool cabinet, back	965 x 600	Dark grey RAL7024		634502	*
Tool panel tool cabinet, door	335 x 600			634503	*

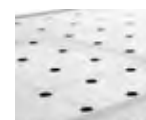

Retractable collection tray with capacity of 50 litres.



The cabinet has good ventilation with two supply air vents and ventilation nozzle at the top for connection to external ventilation.

Extra shelf
SKU: 108994
Price *

SMV Oil Cabinet

A series of fully welded ovens with a collection container at the bottom, for use in workshops, industry, schools and public administration. The doors have hidden hinges and are equipped with cylinder locks. The cabinet comes complete with 2 removable galvanized shelves. The depth of the shelves is less than the depth of the cabinet – so you can place lying plastic containers with a tap. In the bottom of the cabinet is placed a loose collection vessel, with a capacity of 50 liters. The cabinet has ventilation valves at the side and Ø100 mm ventilation socket at the top, for connection to external ventilation.

H x W x D (mm)	Ant. shelves	Load (kg)	SKU	Price
1990 x 1000 x 435	2	75	635875	*

*) Contact Sono for prices



ErgoIT PC Cabinet

ErgoIT is a preassembled computer cabinet, designed to protect PC equipment in production and warehouse environments. The display cabinet (light opening 590 x 590 mm) has a lockable door with recessed plexiglass. The keyboard is retractable and also features a sideways retractable mouse table. In the lower part of the cabinet there is a lockable compartment for storing the PC, in a practical swivel PC holder. To compensate for uneven ground, ErgoIT has adjustable still feet. The enclosure is supplied in environmentally friendly powder coated dark grey RAL7024 or light grey RAL7004.

Lock Type	Key lock			
Weight (kg)	40			
H x W x D (mm)	Hull Color	Door Color	SKU	Price
1673 x 642 x 295	Dark grey RAL7024	Dark grey RAL7024	636410	*
1673 x 642 x 295	Grey RAL7004	Grey RAL7004	636303	*

Industrial chairs

We offer a selection of chairs to suit most needs. Here you will find everything from the simplest models of work stools to ergonomically designed saddle chairs, as well as the accessories range. Wide range of heights, wheels and upholstery.

GBP



STARDY standing support chair

STARDY is a practical standing support chair with a seat made of PU foam for good seating comfort. The seat is tiltable and follows your movements, avoiding unnecessary wear and tear in the back, hips and legs. The seat height of the chair is adjustable and anti-slip floor protectors are installed in the chassis.

Colour	Seat height (mm)	SKU	Price
Black	620 - 850	301381	*



All-Round

All-Round is a smart and sturdy work chair / wheel stool adapted for those who have a lot of work squatting. In the chair's chassis you will find 5 practical compartments for storing what you use most during a working day, alternatively with a single wheel cross. The chair has a round seat in PU foam with stepless seat height adjustment.

Seat	Black PU foams
Zone diameter (mm)	350
Wheels (mm)	Ø 75
Reel type	Smooth rolling
Black chassis	Blue

Seat height (mm)	Max. load (kg)	SKU	Price
	250	301368	*
350 - 470	250	301369	*
	250	301370	*
470 - 650	250	301372	*
	250	301373	*
350 - 470	250	301374	*
	250	301371	*



All-Round COMFORT

All-Round COMFORT is a smart and sturdy work chair / wheel stool with the option to also adjust the seat angle. In the chair's chassis you will find 5 practical compartments for storing what you use most during a working day. The chair has a body-shaped seat in PU foam and easy, stepless seat height adjustment.

Seat	Black PU foams
Zone diameter (mm)	Width 350, Depth 300
Wheels (mm)	Ø 75
Reel type	Smooth rolling
Black chassis	Blue

Seat height (mm)	Max. load (kg)	SKU	Price
	250	301375	*
390 - 500	250	301376	*
	250	301377	*
500 - 670	250	302136	*
	250	302137	*
	250	302138	*



All-round V-MATIC

If you select the All-Round V-MATIC option, the work chair seat has free movement in all directions, helping to prevent back strain injuries. In the chair's chassis you will find 5 practical compartments for storing what you use most during a working day. The chair has a body-shaped seat in PU foam and easy, stepless seat height adjustment.

Seat	Black PU foams
Zone diameter (mm)	Width 340, Depth 300
Wheels (mm)	Ø 75
Reel type	Smooth rolling
Black chassis	Blue

Seat height (mm)	Max. load (kg)	SKU	Price
	250	301378	*
405 - 535	250	301379	*
	250	301380	*
	250	302133	*
525 - 705	250	302134	*
	250	302135	*



All-Round w/Back

All-Round is a smart and sturdy work chair / wheelchair - here with ergonomic backrest - adapted for those who have a lot of work squatting. In the chair's chassis you will find 5 practical compartments for storing what you use most during a working day, alternatively with a single wheel cross. The chair has a round seat in PU foam with stepless seat height adjustment.

Seat	Black PU foams
Zone diameter (mm)	350
Wheels (mm)	Ø 75
Reel type	Smooth rolling
Black chassis	Blue

Seat height (mm)	Max. load (kg)	SKU	Price
	250	302092	*
350 - 470	250	302093	*
	250	302094	*
	250	302095	*
470 - 650	250	302350	*
	250	302351	*

ASSIST

ASSIST is an ergonomic work chair that stimulates the back and legs, for those who work sitting or standing. The chair has a comfortable PU seat for easy cleaning, as well as stepless adjustment of the seat angle and working height. For the highest version of ASSIST, we recommend the use of glides. Use the table and select the working height, chassis, footrest and wheel type.

Seating height

Low, 420-550 mm	2
Between, 500-690 mm	3
High, 560-820 mm	4
Black chassis	
Wheel intersection Low	4
Wheel intersection Large	5
Foot Ring	
No	0
Yes	1
Reel type	
50 mm Smooth rolling	1
50 mm Sluggish	2
50 mm Load braking	3
Slide Feet	5

41-082-2401

Configure your chair by changing the last digits of the article number



Price example
SKU 41-082-2401 . Price *



Price example
SKU 41-082-4515 . Price *

ASSIST V-MATIC

This version of the ASSIST work chair has the unique seat mechanism V-MATIC, which provides free movement in all directions. ASSIST V-MATIC is an ergonomic work chair that actively stimulates the back and neck and prevents repetitive strain injuries. The chair has a comfortable PU seat for easy cleaning, as well as stepless adjustment of working height. For the highest version of ASSIST V-MATIC, we recommend the use of glides. Use the table and select the working height, chassis, footrest and wheel type.

V-MATIC



Seating height

Low, 420-550 mm	2
Between, 500-690 mm	3
High, 560-820 mm	4
Black chassis	
Wheel intersection Low	4
Wheel intersection Large	5
Foot Ring	
No	0
Yes	1
Reel type	
50 mm Smooth rolling	1
50 mm Sluggish	2
50 mm Load braking	3
Slide Feet	5

41-085-2401

Configure your chair by changing the last digits of the article number



Price example
SKU 41-085-2401 . Price *



Price example
SKU 41-085-4515 . Price *

Work Chair Accessories

Here you can order accessories for ASSIST, DYNAMIC, INDUSTRY, LEGOLAS or STINGRAY work chairs. If things didn't turn out quite as you thought in the first place...

	SKU	Price
Easy rolling std.wheels, 5-pack	204613	*
Slow rolling wheels, 5-pack	204635	*
Load-braking wheels, 5-pack	204634	*
Sliding feet, 5-pack	204608	*
Armrest, h + v	204632	*
Foot Ring	204614	*

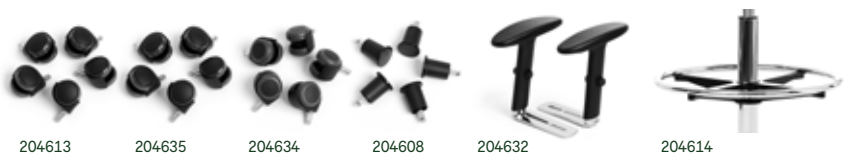

204613 204635 204634 204608 204632 204614

LEGOLA Saddle Chair

With LEGOLAS you are given every opportunity to design exactly the saddle chair you want. The saddle seat of the LEGOLAS is ergonomically and comfortably designed for active sitting with stimulation of the back and neck. Choose a PU foam seat for easy cleaning, or a fabric you find appealing. Also, the seating height and other accessories must be adapted to your needs. For the highest version of LEGOLAS, we recommend the use of glides. Use the table and select the working height, chassis, footrest, wheel type and upholstery.

Seating height

Low, 420-550 mm	2
Between, 550-730 mm	3
High, 620-870 mm	4

Black chassis

Wheel intersection Low	4
Wheel intersection Large	5

Foot Ring

No	0
Yes	1

Reel type

50 mm Smooth rolling	1
50 mm Sluggish	2
50 mm Load braking	3
Slide Feet	5

Upholstery, standard

PU foams	0
Upholstery fabric, black	1
Upholstery fabric, graphite grey	2
Upholstery fabric, blue	3
Vinyl, Black	4
Vinyl, grey	5

42-037-24014 ←



Price example

SKU 42-037-24014 . Price *



Price example

SKU 42-037-45150 . Price *

Configure your chair by changing the last digits of the article number

INDUSTRY

This is the industrial chair with the many choices. INDUSTRY is available with high or low backrests and in different designs in terms of fabric for seat and backrest. Choose upholstery or artificial leather (PU) for easier cleaning, where necessary. Asynchronous adjustment mechanism allows the chair to be easily adjusted while sitting on it. Stepless adjustment of the seat, back angle and seat height. For the highest version of INDUSTRY, we recommend the use of glides. Use the table and select the working height, back height, footrest, wheel type, armrest and upholstery.

Seating height

Low, 420-550 mm	2
Between, 550-730 mm	3
High, 620-870 mm	4

Backrest

High	2
Low	3

Black chassis

Wheel intersection Large	5
--------------------------	---

Foot Ring

No	0
Yes	1

Reel type

50 mm Smooth rolling	1
50 mm Sluggish	2
50 mm Load braking	3
Slide Feet	5

Armrests

No	0
Yes	1

Upholstery, standard

Upholstery fabric, black	1
Upholstery fabric, graphite grey	2
Upholstery fabric, blue	3
Vinyl, Black	4

41-064-2250104 ←



Price example

SKU 41-064-2250104 . Price *



Price example

SKU 41-064-4251511 . Price *

Configure your chair by changing the last digits of the article number

STINGRAY COMFORT

STINGRAY COMFORT is a comfortable saddle chair including backrest, both the saddle seat and the back are PU foam for easy cleaning and rugged use. The asynchronous mechanism allows the chair to be easily adjusted when in use. Stepless adjustment of the seat, back angle and seat height. Choose the model and equipment tailored to your needs. For the highest version of STINGRAY COMFORT, we recommend the use of glides. Use the table and select the working height, chassis, footrest and wheel type.

Seating height

Low, 420-550 mm

Between, 550-730 mm

High, 620-870 mm

Black chassis

Wheel intersection Low

Wheel intersection Large

Foot Ring

No

Yes

Reel type

50 mm Smooth rolling

50 mm Sluggish

50 mm Load braking

Slide Feet

41-076-2401

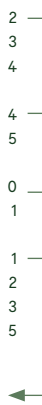

Price example
SKU 41-076-2401 . Price *



Price example
SKU 41-076-4515 . Price *

Configure your chair by changing the last digits of the article number

STINGRAY V-MATIC

The STINGRAY V-MATIC is a proper saddle chair that comes without a backrest, but with the unique V-MATIC seat mechanism. It provides free movement in all directions. Choose a seat made of upholstery, artificial leather or PU foam with hygiene requirements. V-MATIC thus provides free movement when the chair is in use, otherwise there is of course infinitely variable adjustment of the seat height. Choose the model and equipment tailored to your needs. For the highest version of STINGRAY V-MATIC, we recommend the use of glides. Use the table and select the working height, chassis, footrest, wheel type and upholstery.

Seating height

Low, 420-550 mm

Between, 550-730 mm

High, 620-870 mm

Black chassis

Wheel intersection Low

Wheel intersection Large

Foot Ring

No

Yes

Reel type

50 mm Smooth rolling

50 mm Sluggish

50 mm Load braking

Slide Feet

Upholstery, standard

PU foams

Upholstery fabric, black

Upholstery fabric, graphite grey

Upholstery fabric, blue

Vinyl, Black

Vinyl, grey

41-079-24011



Price example
SKU 41-079-24011 . Price *



Price example
SKU 41-079-45150 . Price *

Configure your chair by changing the last digits of the article number



DYNAMIC

DYNAMIC is a quality chair with a seat and back in PU foam, with asynchronous adjustment mechanism that can be easily adjusted while sitting on the chair. Dynamic has stepless adjustment of the seat, back angle and seat height. Comes with or without armrests. For the highest version of Dynamic, we recommend the use of glides. Using the table, select the working height, footrest, wheel type and armrest.

Seating height

Low, 400-530 mm

Between, 520-700 mm

High, 600-850 mm

Black chassis

Wheel intersection Large

Foot Ring

No

Yes

Reel type

50 mm Smooth rolling

50 mm Sluggish

50 mm Load braking

Slide Feet

Armrests

No

Yes

41-061-25010

Configure your chair by changing the last digits of the article number



Price example
SKU 41-061-25010 . Price *



Price example
SKU 41-061-45151 . Price *

DYNAMIC COMFORT

DYNAMIC COMFORT is an ergonomic quality chair with a body-shaped seat and back in PU foam. The asynchronous adjustment mechanism can be easily adjusted while sitting on the chair. Dynamic has stepless adjustment of the seat, back angle and seat height. Comes with or without armrests. For the highest version of DYNAMIC COMFORT, we recommend the use of glides. Using the table, select the working height, footrest, wheel type and armrest.

Seating height

Low, 420-550 mm

Between, 540-720 mm

High, 620-870 mm

Black chassis

Wheel intersection Large

Foot Ring

No

Yes

Reel type

50 mm Smooth rolling

50 mm Sluggish

50 mm Load braking

Slide Feet

Armrests

No

Yes

41-864-25010

Configure your chair by changing the last digits of the article number



Price example
SKU 41-864-25010 . Price *



Price example
SKU 41-864-45151 . Price *

BASIC

BASIC is a work chair with a polyurethane seat for easier cleaning. The low version comes with wheels, while the high one has footrest and glides. Wheelset (103193) is available as an option.

	Seat width (mm)	Working Height (mm)	SKU	Price
Low model	460 x 440	380 - 510	102438	*
High model		530 - 780	102439	*

**Wheelset for Industrial Chairs**

SKU 103193. Price *



GOLIAT

GOLIATH is a good industrial chair with no back. Choose between high or low edition, as well as chair cushion in textile or vinyl. The high version has footrest and "glides" to ensure stability, wheelset (103193) is available as an option. The low work chair is supplied with wheels.

	Seat width (mm)	Working Height (mm)	SKU	Price
Low model, vinyl	Ø360	395 - 530	102443	*
Low model, textile		395 - 530	102444	*
High model, vinyl		520 - 785	102445	*
Tall model, textile		520 - 785	102446	*



WORKER

THE WORKER's seat cushion has a raised rear edge for better seating comfort. This high version has footrest and to ensure stability the chassis has "glides". Wheelset (103193) is available as an option.

Seat width (mm)	Working Height (mm)	SKU	Price
350 x 345	605 - 860	102440	*



REGAL

THE REGAL has an adjustable seat back. This high version has footrest and to ensure stability the chassis has "glides". Wheelset (103193) is available as an option.

Seat width (mm)	Working Height (mm)	SKU	Price
455 x 405	600 - 845	102448	*



SENIOR

SENIOR is a comfortable industrial chair with a textile chair cushion. This version has footrest and to ensure stability the chassis has "glides". Wheelset (103193) is available as an option.

Seat width (mm)	Working Height (mm)	SKU	Price
440 x 395	600 - 845	102447	*



Ergo classic

Ergo Classic is a recyclable 10 mm thick vinyl workplace mat made up of millions of air bubbles. The ribbed surface provides good friction and good friction, bevelled edges reduce the risk of tripping. The mat's soft, cushioning properties also help reduce the risk of slipping, as well as effectively insulating against cold and vibrations. The Ergo Classic industrial mat meets the standard R10 DIN 51130, preventing the risk of tripping injuries. Application: at workbenches and machining in dry, light work environments such as warehouses, at packing tables or assembly lines.

Colour	Grey		
Thickness (mm)	9		
	Unit	SKU	Price
610 x 18300	Pcs roll	302066	*
910 x 18300	Pcs roll	302067	*
1220 x 18300	Pcs roll	302068	*
910 x lpm	Running Meters	302157	*
1220 x lpm	Running Meters	302158	*
610 x lpm	Running Meters	396521	*



Ergo Weld

Ergo Weld is an industrial mat that is particularly suitable for workplaces where grinding and welding work is carried out. The mat is fire tested and approved according to class B1. The vinyl surface is oil-resistant and fire-retardant with a soft underside providing good comfort and improved ergonomics in the workplace. Applications include heavy industry, workshops and grinding and welding sites.

Colour	Black		
Thickness (mm)	11		
	Unit	SKU	Price
910 x 1500	Pcs	302147	*
910 x lpm	Running Meters	302161	*
910 x 18300	Pcs roll	435536	*



Ergo Trax

Ergo Trax is a sleek workplace mat with a door patterned surface, with a soft and cushioning underside of polyvinyl that provides good ergonomics and comfort. The bevelled edges reduce the risk of tripping. This 13 mm thick mat effectively insulates against cold, vibration and provides better ergonomics at e.g. workbenches, machines, packing counters or at assembly lines. Applications are dry, light work environments such as retail stores, warehouses or at packing and assembly lines.

Colour	Black		
Thickness (mm)	13		
	Unit	SKU	Price
910 x 18300	Pcs roll	302141	*
910 x 1520	Pcs	302142	*



Ergo Stripe

A durable workplace mat with a floor patterned surface, with a soft and cushioning underside of polyvinyl for good ergonomics and comfort. The bevelled edges reduce the risk of tripping. This 12 mm thick mat effectively insulates against cold, vibration and provides better ergonomics at e.g. workbenches, machines, packing counters or at assembly lines. Applications are dry, light work environments such as retail stores, warehouses or at packing and assembly lines.

Colour	Black, yellow longitudinal edge		
Thickness (mm)	12		
	Unit	SKU	Price
900 x 1200	Pcs	436179	*
900 x 1500	Pcs	436180	*
900 x 2000	Pcs	436181	*
600 x 18,000	Pcs roll	436182	*
900 x 18,000	Pcs roll	436183	*
600 x lpm	Running Meters	576105	*
900 x lpm	Running Meters	576109	*

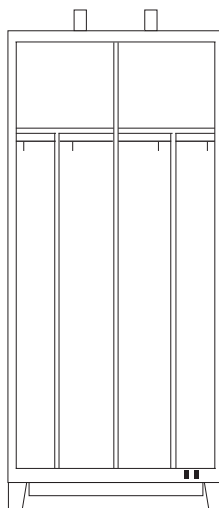

Effective drying cabinet

Fully welded drying cabinet with integrated heat source with 1000W power - and possibility of connection to external ventilation (Ø80 mm nozzle). Choose between padlock or cylinder lock hasp. The drying cabinet has two separate compartments, each with vertical divider, hat rack and clothes rail with hook.

	W x D x H (mm)	SKU	Price
Padlock Hasp	800 x 490 x 2060	116967	*
Cylinder lock	800 x 490 x 2060	116966	*



Cleaning Cart

A mobile trolley to facilitate an aseptic way of working. Compliance and disinfection of surfaces and spaces is of particular importance, especially in public spaces. Cleaning products must be readily available and sterile. Cleaning trolley and accessories allow the trolley to be configured according to each individual need and adapted to different applications and cleaning equipment.

Dimensions of trolley H x W x D (mm)	Weight (kg)	SKU	Price
1570 x 820 x 700	28	565394	*
		Detergent pump	565395



GBP is changing the color of the product range!

In February, we changed the color of the entire industrial range under the brand GBP. Our new color scheme has a light gray base and a dark gray accent color. The reason for the color change is that the working environment in the workshop and industrial sector has evolved over the years. Now, there is a desire for a clean and stylish work environment where the interior is both functional and elegant. With this change in color, we present the market with a timeless design. Products such as tool boards and tool cabinets will still be available in our classic blue color. You will still be able to purchase products in the old colors for a limited period, and as long as stock lasts.

GBP



